



# Vietnam Price List 2024

[www.himel.com](http://www.himel.com)





We are determined to build a world where electricity is *safe and accessible* to one and all

Himel is a global manufacturer and supplier of electric products for Low Voltage Power Distribution, Final Distribution, Power Management, Motor Control and Protection, Industrial Components, and Home Electric offers.

## Global. Reliable. Affordable.

**55+**

**countries served**



RESIDENTIAL



COMMERCIAL



INDUSTRIAL

**8,300+**  
resellers

**32K+**  
products

With a footprint in 50+ countries—we are leaders in value-engineered electric products for residential, commercial, industrial, and utilities sectors. We value opportunities for all and provide the best combination of affordable and reliable offers to meet the demand for access to safe electricity.

**Low Voltage  
Power Distribution**



**Final  
Distribution**



**Power  
Management**



**Motor  
Control &  
Protection**



**Industrial  
Components**



**Home  
Electric**



# Vietnam

## Price List 2024



<b>02</b>	Himel Company Profile
<b>03</b>	Index
<b>04</b>	Miniature Circuit Breaker
<b>07</b>	RCBO
<b>09</b>	Molded Case Circuit Breaker
<b>15</b>	ELCB
<b>18</b>	Air Circuit Breaker
<b>22</b>	Automatic Transfer Switch
<b>23</b>	Contactor
<b>28</b>	Thermal Overload Relay
<b>29</b>	Surge Protective Device
<b>31</b>	Distribution Box
<b>32</b>	Fuse
<b>33</b>	Inverter
<b>37</b>	Indicator Light

# Miniature Circuit Breaker (MCB)

IEC/EN 60898-1



## HDB3WN MCB 6kA - Type C





Product Image	Pole	Icu (kA)	In (A)	Description	Model	Price
	1P	6KA	6A	HDB3 1P 6A 6KA	HDB3WN1C6	60.000
			10A	HDB3 1P 10A 6KA	HDB3WN1C10	
			16A	HDB3 1P 16A 6KA	HDB3WN1C16	
			20A	HDB3 1P 20A 6KA	HDB3WN1C20	
			25A	HDB3 1P 25A 6KA	HDB3WN1C25	65.000
			32A	HDB3 1P 32A 6KA	HDB3WN1C32	
			40A	HDB3 1P 40A 6KA	HDB3WN1C40	
			50A	HDB3 1P 50A 6KA	HDB3WN1C50	74.800
63A	HDB3 1P 63A 6KA		HDB3WN1C63			
	2P		6A	HDB3 2P 6A 6KA	HDB3WN2C6	120.000
			10A	HDB3 2P 10A 6KA	HDB3WN2C10	
			16A	HDB3 2P 16A 6KA	HDB3WN2C16	
			20A	HDB3 2P 20A 6KA	HDB3WN2C20	
			25A	HDB3 2P 25A 6KA	HDB3WN2C25	125.000
			32A	HDB3 2P 32A 6KA	HDB3WN2C32	
			40A	HDB3 2P 40A 6KA	HDB3WN2C40	
			50A	HDB3 2P 50A 6KA	HDB3WN2C50	146.300
63A	HDB3 2P 63A 6KA		HDB3WN2C63			
	3P		6A	HDB3 3P 6A 6KA	HDB3WN3C6	176.000
			10A	HDB3 3P 10A 6KA	HDB3WN3C10	
			16A	HDB3 3P 16A 6KA	HDB3WN3C16	
			20A	HDB3 3P 20A 6KA	HDB3WN3C20	
			25A	HDB3 3P 25A 6KA	HDB3WN3C25	187.000
			32A	HDB3 3P 32A 6KA	HDB3WN3C32	
		40A	HDB3 3P 40A 6KA	HDB3WN3C40		
		50A	HDB3 3P 50A 6KA	HDB3WN3C50	214.500	
63A	HDB3 3P 63A 6KA	HDB3WN3C63				
	4P	6A	HDB3 4P 6A 6KA	HDB3WN4C6	245.300	
		10A	HDB3 4P 10A 6KA	HDB3WN4C10		
		16A	HDB3 4P 16A 6KA	HDB3WN4C16		
		20A	HDB3 4P 20A 6KA	HDB3WN4C20		
		25A	HDB3 4P 25A 6KA	HDB3WN4C25	264.000	
		32A	HDB3 4P 32A 6KA	HDB3WN4C32		
		40A	HDB3 4P 40A 6KA	HDB3WN4C40		
		50A	HDB3 4P 50A 6KA	HDB3WN4C50	289.300	
63A	HDB3 4P 63A 6KA	HDB3WN4C63				

# Miniature Circuit Breaker (MCB)

IEC/EN 60898-1



## HDB9H MCB 10kA - Type C

Product Image	Pole	Icu (kA)	In (A)	Description	Model	Price
	1P	10KA	6A	HDB9 1P 6A 10KA	HDB9H63A1C6	118.800
			10A	HDB9 1P 10A 10KA	HDB9H63A1C10	
			16A	HDB9 1P 16A 10KA	HDB9H63A1C16	
			20A	HDB9 1P 20A 10KA	HDB9H63A1C20	
			25A	HDB9 1P 25A 10KA	HDB9H63A1C25	129.800
			32A	HDB9 1P 32A 10KA	HDB9H63A1C32	
			40A	HDB9 1P 40A 10KA	HDB9H63A1C40	
			50A	HDB9 1P 50A 10KA	HDB9H63A1C50	132.000
63A	HDB9 1P 63A 10KA		HDB9H63A1C63			
	2P		6A	HDB9 2P 6A 10KA	HDB9H63A2C6	206.800
			10A	HDB9 2P 10A 10KA	HDB9H63A2C10	
			16A	HDB9 2P 16A 10KA	HDB9H63A2C16	
			20A	HDB9 2P 20A 10KA	HDB9H63A2C20	
			25A	HDB9 2P 25A 10KA	HDB9H63A2C25	223.300
			32A	HDB9 2P 32A 10KA	HDB9H63A2C32	
			40A	HDB9 2P 40A 10KA	HDB9H63A2C40	
			50A	HDB9 2P 50A 10KA	HDB9H63A2C50	233.000
63A	HDB9 2P 63A 10KA		HDB9H63A2C63			
	3P		6A	HDB9 3P 6A 10KA	HDB9H63A3C6	280.500
			10A	HDB9 3P 10A 10KA	HDB9H63A3C10	
			16A	HDB9 3P 16A 10KA	HDB9H63A3C16	
			20A	HDB9 3P 20A 10KA	HDB9H63A3C20	
			25A	HDB9 3P 25A 10KA	HDB9H63A3C25	313.500
			32A	HDB9 3P 32A 10KA	HDB9H63A3C32	
		40A	HDB9 3P 40A 10KA	HDB9H63A3C40		
		50A	HDB9 3P 50A 10KA	HDB9H63A3C50	322.300	
63A	HDB9 3P 63A 10KA	HDB9H63A3C63				
	4P	6A	HDB9 4P 6A 10KA	HDB9H63A4C6	360.800	
		10A	HDB9 4P 10A 10KA	HDB9H63A4C10		
		16A	HDB9 4P 16A 10KA	HDB9H63A4C16		
		20A	HDB9 4P 20A 10KA	HDB9H63A4C20		
		25A	HDB9 4P 25A 10KA	HDB9H63A4C25	404.800	
		32A	HDB9 4P 32A 10KA	HDB9H63A4C32		
		40A	HDB9 4P 40A 10KA	HDB9H63A4C40		
		50A	HDB9 4P 50A 10KA	HDB9H63A4C50	415.800	
63A	HDB9 4P 63A 10KA	HDB9H63A4C63				

# Miniature Circuit Breaker (MCB)

IEC/EN 60898-1



## HDB3W-125 MCB 125 10kA - Type C

Product Image	Pole	Icu (kA)	In (A)	Description	Model	Price
	1P	10KA	80A	HDB3 1P 80A 10KA	HDB3W125H1C80	162.800
			100A	HDB3 1P 100A 10KA	HDB3W125H1C100	
			125A	HDB3 1P 125A 10KA	HDB3W125H1C125	182.000
	2P		80A	HDB3 2P 80A 10KA	HDB3W125H2C80	319.000
			100A	HDB3 2P 100A 10KA	HDB3W125H2C100	
			125A	HDB3 2P 125A 10KA	HDB3W125H2C125	356.000
	3P		80A	HDB3 3P 80A 10KA	HDB3W125H3C80	473.000
			100A	HDB3 3P 100A 10KA	HDB3W125H3C100	
			125A	HDB3 3P 125A 10KA	HDB3W125H3C125	519.000
	4P	80A	HDB3 4P 80A 10KA	HDB3W125H4C80	630.300	
		100A	HDB3 4P 100A 10KA	HDB3W125H4C100		
		125A	HDB3 4P 125A 10KA	HDB3W125H4C125	708.000	

# Residual Current Operated Circuit Breaker (RCBO)

IEC/EN 60898-1



## HDB3WLE RCBO 10kA - 30mA - Type C/D



Pole	Icu (kA)	I <sub>Δn</sub> (mA)	In (A)	Type	Description	Model	Price	
1P+N	10kA	30mA	80A	C	HDB3wLE-125 1P+N C 80A	HDB3WLE1251C80	704.000	
			100A		HDB3wLE-125 1P+N C 100A	HDB3WLE1251C100	762.000	
			125A		HDB3wLE-125 1P+N C 125A	HDB3WLE1251C125		
			80A	D	HDB3wLE-125 1P+N D 80A	HDB3WLE1251D80	725.000	
			100A		HDB3wLE-125 1P+N D 100A	HDB3WLE1251D100	785.000	
			125A		HDB3wLE-125 1P+N D 125A	HDB3WLE1251D125		
2P			C	80A	HDB3wLE-125 2P C 80A	HDB3WLE1252C80	748.000	
				100A	HDB3wLE-125 2P C 100A	HDB3WLE1252C100	809.000	
				125A	HDB3wLE-125 2P C 125A	HDB3WLE1252C125		
				D	80A	HDB3wLE-125 2P D 80A	HDB3WLE1252D80	769.000
					100A	HDB3wLE-125 2P D 100A	HDB3WLE1252D100	834.000
					125A	HDB3wLE-125 2P D 125A	HDB3WLE1252D125	
3P	C	80A	HDB3wLE-125 3P C 80A	HDB3WLE1253C80	1.127.000			
		100A	HDB3wLE-125 3P C 100A	HDB3WLE1253C100	1.221.000			
		125A	HDB3wLE-125 3P C 125A	HDB3WLE1253C125				
		D	80A	HDB3wLE-125 3P D 80A	HDB3WLE1253D80	1.160.000		
			100A	HDB3wLE-125 3P D 100A	HDB3WLE1253D100	1.257.000		
			125A	HDB3wLE-125 3P D 125A	HDB3WLE1253D125			
4P	C	80A	HDB3wLE-125 4P C 80A	HDB3WLE1254C80	1.466.000			
		100A	HDB3wLE-125 4P C 100A	HDB3WLE1254C100	1.588.000			
		125A	HDB3wLE-125 4P C 125A	HDB3WLE1254C125				
		D	80A	HDB3wLE-125 4P D 80A	HDB3WLE1254D80	1.510.000		
			100A	HDB3wLE-125 4P D 100A	HDB3WLE1254D100	1.635.000		
			125A	HDB3wLE-125 4P D 125A	HDB3WLE1254D125			
3P+N	C	80A	HDB3wLE-125 3P+N C 80A	HDB3WLE1256C80	1.444.000			
		100A	HDB3wLE-125 3P+N C 100A	HDB3WLE1256C100	1.564.000			
		125A	HDB3wLE-125 3P+N C 125A	HDB3WLE1256C125				
		D	80A	HDB3wLE-125 3P+N D 80A	HDB3WLE1256D80	1.487.000		
			100A	HDB3wLE-125 3P+N D 100A	HDB3WLE1256D100	1.611.000		
			125A	HDB3wLE-125 3P+N D 125A	HDB3WLE1256D125			

# Residual Current Operated Circuit Breaker (RCBO)

IEC/EN 60898-1



## HDB3LE RCBO 6kA - 30mA - Type C



Pole	Icu (kA)	I <sub>Δn</sub> (mA)	In (A)	Type	Description	Model	Price
2P	6kA	30mA	6A	A Type	HDB3LE 2P C 6A 30mA A	HDB3LE2C6A	399.000
			10A		HDB3LE 2P C 10A 30mA A	HDB3LE2C10A	362.000
			16A		HDB3LE 2P C 16A 30mA A	HDB3LE2C16A	380.000
			20A		HDB3LE 2P C 20A 30mA A	HDB3LE2C20A	
			25A		HDB3LE 2P C 25A 30mA A	HDB3LE2C25A	
			32A		HDB3LE 2P C 32A 30mA A	HDB3LE2C32A	395.000
			40A		HDB3LE 2P C 40A 30mA A	HDB3LE2C40A	512.000
			50A		HDB3LE 2P C 50A 30mA A	HDB3LE2C50A	648.000
			63A		HDB3LE 2P C 63A 30mA A	HDB3LE2C63A	613.000
3P	6kA	30mA	6A	A Type	HDB3LE 3P C 6A 30mA A	HDB3LE3C6A	602.000
			10A		HDB3LE 3P C 10A 30mA A	HDB3LE3C10A	545.000
			16A		HDB3LE 3P C 16A 30mA A	HDB3LE3C16A	
			20A		HDB3LE 3P C 20A 30mA A	HDB3LE3C20A	
			25A		HDB3LE 3P C 25A 30mA A	HDB3LE3C25A	568.000
			32A		HDB3LE 3P C 32A 30mA A	HDB3LE3C32A	
			40A		HDB3LE 3P C 40A 30mA A	HDB3LE3C40A	
			50A		HDB3LE 3P C 50A 30mA A	HDB3LE3C50A	880.000
			63A		HDB3LE 3P C 63A 30mA A	HDB3LE3C63A	782.000
6A	HDB3LE 4P C 6A 30mA A	HDB3LE4C6A					
10A	HDB3LE 4P C 10A 30mA A	HDB3LE4C10A					
4P	6kA	30mA	16A	A Type	HDB3LE 4P C 16A 30mA A	HDB3LE4C16A	745.000
			20A		HDB3LE 4P C 20A 30mA A	HDB3LE4C20A	
			25A		HDB3LE 4P C 25A 30mA A	HDB3LE4C25A	
			32A		HDB3LE 4P C 32A 30mA A	HDB3LE4C32A	775.000
			40A		HDB3LE 4P C 40A 30mA A	HDB3LE4C40A	1.003.000
			50A		HDB3LE 4P C 50A 30mA A	HDB3LE4C50A	1.201.000
			63A		HDB3LE 4P C 63A 30mA A	HDB3LE4C63A	

## HDB3PLE RCBO 3.5kA - 30mA - Type C



Pole	Icu (kA)	I <sub>Δn</sub> (mA)	In (A)	Type	Description	Model	Price
1P+N	3.5kA	30mA	6A	C	HDB3PLE 1P+N C 6A	HDB3PLEC6	478.000
			10A		HDB3PLE 1P+N C 10A	HDB3PLEC10	423.000
			16A		HDB3PLE 1P+N C 16A	HDB3PLEC16	
			20A		HDB3PLE 1P+N C 20A	HDB3PLEC20	
			25A		HDB3PLE 1P+N C 25A	HDB3PLEC25	440.000
			32A		HDB3PLE 1P+N C 32A	HDB3PLEC32	
			40A		HDB3PLE 1P+N C 40A	HDB3PLEC40	





# Molded Case Circuit Breaker (MCCB)

IEC/EN 60947-2



## HDM2 MCCB

Product Image	Pole	Icu (kA)	In (A)	Frame Size (AF)	Description	Model	Price
	1	20	10A	125	HDM2-125L 1P 10A	HDM2125L0101	580.000
			16A	125	HDM2-125L 1P 16A	HDM2125L0161	
			20A	125	HDM2-125L 1P 20A	HDM2125L0201	
			25A	125	HDM2-125L 1P 25A	HDM2125L0251	
			32A	125	HDM2-125L 1P 32A	HDM2125L0321	
			40A	125	HDM2-125L 1P 40A	HDM2125L0401	
			50A	125	HDM2-125L 1P 50A	HDM2125L0501	630.000
			63A	125	HDM2-125L 1P 63A	HDM2125L0631	
			80A	125	HDM2-125L 1P 80A	HDM2125L0801	
			100A	125	HDM2-125L 1P 100A	HDM2125L1001	
			125A	125	HDM2-125L 1P 125A	HDM2125L1251	
	2	20	10A	125	HDM2-125L 2P 10A	HDM2125L0102	1.061.500
			16A	125	HDM2-125L 2P 16A	HDM2125L0162	828.300
			20A	125	HDM2-125L 2P 20A	HDM2125L0202	
			25A	125	HDM2-125L 2P 25A	HDM2125L0252	
			32A	125	HDM2-125L 2P 32A	HDM2125L0322	
			40A	125	HDM2-125L 2P 40A	HDM2125L0402	
			50A	125	HDM2-125L 2P 50A	HDM2125L0502	
			63A	125	HDM2-125L 2P 63A	HDM2125L0632	
			80A	125	HDM2-125L 2P 80A	HDM2125L0802	
			100A	125	HDM2-125L 2P 100A	HDM2125L1002	
			125A	125	HDM2-125L 2P 125A	HDM2125L1252	

# Molded Case Circuit Breaker (MCCB)

IEC/EN 60947-2



## HDM3 MCCB (Thermal Magnetic Unit) 3 Pole



Pole	Icu (kA)	In (A)	Frame Size (AF)	Description	Model	Price			
3 Pole	25KA	10A	100	HDM3-100S 3P 10A	HDM3100S1033XX	1.133.000			
		16A	100	HDM3-100S 3P 16A	HDM3100S1633XX				
		20A	100	HDM3-100S 3P 20A	HDM3100S2033XX				
		25A	100	HDM3-100S 3P 25A	HDM3100S2533XX				
		32A	100	HDM3-100S 3P 32A	HDM3100S3233XX				
		40A	100	HDM3-100S 3P 40A	HDM3100S4033XX				
		50A	100	HDM3-100S 3P 50A	HDM3100S5033XX				
		63A	100	HDM3-100S 3P 63A	HDM3100S6333XX				
		80A	100	HDM3-100S 3P 80A	HDM3100S8033XX		1.150.000		
	100A	100	HDM3-100S 3P 100A	HDM3100S10033XX					
	35KA	35KA	125A	160	HDM3-160S 3P 125A	HDM3160S12533XX	1.364.000		
			140A	160	HDM3-160S 3P 140A	HDM3160S14033XX			
			160A	160	HDM3-160S 3P 160A	HDM3160S16033XX			
			160A	250	HDM3-250S 3P 160A	HDM3250S16033XX			
			180A	250	HDM3-250S 3P 180A	HDM3250S18033XX			
			200A	250	HDM3-250S 3P 200A	HDM3250S20033XX			
			225A	250	HDM3-250S 3P 225A	HDM3250S22533XX	1.380.000		
	250A	250	HDM3-250S 3P 250A	HDM3250S25033XX					
	36KA	36KA	100A	160	HDM3-160T 3P 100A	HDM3160T10033XX	1.752.300		
			125A	160	HDM3-160T 3P 125A	HDM3160T12533XX			
			140A	160	HDM3-160T 3P 140A	HDM3160T14033XX			
			160A	160	HDM3-160T 3P 160A	HDM3160T16033XX			
			160A	250	HDM3-250T 3P 160A	HDM3250T16033XX			
			180A	250	HDM3-250T 3P 180A	HDM3250T18033XX			
			200A	250	HDM3-250T 3P 200A	HDM3250T20033XX			
			225A	250	HDM3-250T 3P 225A	HDM3250T22533XX			
			250A	250	HDM3-250T 3P 250A	HDM3250T25033XX			
			50KA	50KA	40A	100		HDM3-100N 3P 40A	HDM3100N4033XX
50A					100	HDM3-100N 3P 50A		HDM3100N5033XX	
63A					100	HDM3-100N 3P 63A		HDM3100N6333XX	
80A					100	HDM3-100N 3P 80A		HDM3100N8033XX	
100A	100	HDM3-100N 3P 100A			HDM3100N10033XX				

# Molded Case Circuit Breaker (MCCB)

IEC/EN 60947-2



## HDM3 MCCB (Thermal Magnetic Unit) 3 Pole

Pole	Icu (kA)	In (A)	Frame Size (AF)	Description	Model	Price		
3 Pole	60KA	100A	160	HDM3-160N 3P 100A	HDM3160N10033XX	1.950.000		
		125A	160	HDM3-160N 3P 125A	HDM3160N12533XX			
		140A	160	HDM3-160N 3P 140A	HDM3160N14033XX			
		160A	160	HDM3-160N 3P 160A	HDM3160N16033XX			
		160A	250	HDM3-250N 3P 160A	HDM3250N16033XX			
		180A	250	HDM3-250N 3P 180A	HDM3250N18033XX			
		200A	250	HDM3-250N 3P 200A	HDM3250N20033XX			
		225A	250	HDM3-250N 3P 225A	HDM3250N22533XX			
		250A	250	HDM3-250N 3P 250A	HDM3250N25033XX			
	70KA	400	200A	400	HDM3-400N 3P 200A	HDM3400N20033XX	5.250.000	
			225A	400	HDM3-400N 3P 225A	HDM3400N22533XX		
			250A	400	HDM3-400N 3P 250A	HDM3400N25033XX		
			315A	400	HDM3-400N 3P 315A	HDM3400N31533XX		
			350A	400	HDM3-400N 3P 350A	HDM3400N35033XX		
			400A	400	HDM3-400N 3P 400A	HDM3400N40033XX		
		630	500A	630	HDM3-630N 3P 500A	HDM3630N50033XX	6.650.000	
			630A	630	HDM3-630N 3P 630A	HDM3630N63033XX		
			800	700A	800	HDM3-800F 3P 700A	HDM3800F70033XX	11.700.000
				800A	800	HDM3-800F 3P 800A	HDM3800F80033XX	
1600	1000A	1600	HDM3-1600N 3P 1000A	HDM31600N100033XX	28.500.000			
	1250A	1600	HDM3-1600N 3P 1250A	HDM31600N125033XX	29.500.000			
	1600A	1600	HDM3-1600N 3P 1600A	HDM31600N160033XX	30.235.100			

# Molded Case Circuit Breaker (MCCB)

IEC/EN 60947-2



## HDM3 MCCB (Thermal Magnetic Unit) 4 Pole



Pole	Icu (kA)	In (A)	Frame Size (AF)	Description	Model	Price
4P	25KA	10A	100	HDM3-100S 4P 10A	HDM3100S10B3XX	1.510.000
		16A	100	HDM3-100S 4P 16A	HDM3100S16B3XX	
		20A	100	HDM3-100S 4P 20A	HDM3100S20B3XX	
		25A	100	HDM3-100S 4P 25A	HDM3100S25B3XX	
		32A	100	HDM3-100S 4P 32A	HDM3100S32B3XX	
		40A	100	HDM3-100S 4P 40A	HDM3100S40B3XX	
		50A	100	HDM3-100S 4P 50A	HDM3100S50B3XX	
		63A	100	HDM3-100S 4P 63A	HDM3100S63B3XX	
		80A	100	HDM3-100S 4P 80A	HDM3100S80B3XX	
	100A	100	HDM3-100S 4P 100A	HDM3100S100B3XX		
	35KA	125A	160	HDM3-160S 4P 125A	HDM3160S125B3XX	2.354.000
		140A	160	HDM3-160S 4P 140A	HDM3160S140B3XX	
		160A	160	HDM3-160S 4P 160A	HDM3160S160B3XX	
		160A	250	HDM3-250S 4P 160A	HDM3250S160B3XX	2.618.000
		180A	250	HDM3-250S 4P 180A	HDM3250S180B3XX	
		200A	250	HDM3-250S 4P 200A	HDM3250S200B3XX	
		225A	250	HDM3-250S 4P 225A	HDM3250S225B3XX	
	250A	250	HDM3-250S 4P 250A	HDM3250S250B3XX		
	36KA	100A	160	HDM3-160T 4P 100A	HDM3160T100B3XX	2.535.500
		125A	160	HDM3-160T 4P 125A	HDM3160T125B3XX	
		140A	160	HDM3-160T 4P 140A	HDM3160T140B3XX	
		160A	160	HDM3-160T 4P 160A	HDM3160T160B3XX	2.656.500
		160A	250	HDM3-250T 4P 160A	HDM3250T160B3XX	
		180A	250	HDM3-250T 4P 180A	HDM3250T180B3XX	
		200A	250	HDM3-250T 4P 200A	HDM3250T200B3XX	
		225A	250	HDM3-250T 4P 225A	HDM3250T225B3XX	
	250A	250	HDM3-250T 4P 250A	HDM3250T250B3XX		
	50KA	40A	100	HDM3-100N 4P 40A	HDM3100N40B3XX	2.535.500
		50A	100	HDM3-100N 4P 50A	HDM3100N50B3XX	
		63A	100	HDM3-100N 4P 63A	HDM3100N63B3XX	
		80A	100	HDM3-100N 4P 80A	HDM3100N80B3XX	
		100A	100	HDM3-100N 4P 100A	HDM3100N100B3XX	

# Molded Case Circuit Breaker (MCCB)

IEC/EN 60947-2



## HDM3 MCCB (Thermal Magnetic Unit) 4 Pole

Pole	Icu (kA)	In (A)	Frame Size (AF)	Description	Model	Price
4 Pole	60KA	100A	160	HDM3-160N 4P 100A	HDM3160N100B3XX	2.535.500
		125A	160	HDM3-160N 4P 125A	HDM3160N125B3XX	
		140A	160	HDM3-160N 4P 140A	HDM3160N140B3XX	
		160A	160	HDM3-160N 4P 160A	HDM3160N160B3XX	
		160A	250	HDM3-250N 4P 160A	HDM3250N160B3XX	2.980.000
		180A	250	HDM3-250N 4P 180A	HDM3250N180B3XX	
		200A	250	HDM3-250N 4P 200A	HDM3250N200B3XX	
		225A	250	HDM3-250N 4P 225A	HDM3250N225B3XX	
	250A	250	HDM3-250N 4P 250A	HDM3250N250B3XX		
	70KA	200A	400	HDM3-400N 4P 200A	HDM3400N200B3XX	6.055.500
		225A	400	HDM3-400N 4P 225A	HDM3400N225B3XX	
		250A	400	HDM3-400N 4P 250A	HDM3400N250B3XX	
		315A	400	HDM3-400N 4P 315A	HDM3400N315B3XX	
		350A	400	HDM3-400N 4P 350A	HDM3400N350B3XX	
		400A	400	HDM3-400N 4P 400A	HDM3400N400B3XX	7.197.300
500A		630	HDM3-630N 4P 500A	HDM3630N500B3XX		
630A		630	HDM3-630N 4P 630A	HDM3630N630B3XX		
630A		800	HDM3-800F 4P 630A	HDM3800F630B3XX	15.334.000	
700A		800	HDM3-800F 4P 700A	HDM3800F700B3XX		
800A	800	HDM3-800F 4P 800A	HDM3800F800B3XX			

# Molded Case Circuit Breaker (MCCB)

IEC/EN 60947-2



## HDM3E MCCB (Electronic Unit) 3 Pole

Product Image	Pole	Icu (kA)	In (A)	Frame Size (AF)	Description	Model	Price
	3P	50KA	32A	125	HDM3E-125M 3P 32A	HDM3E125M3233XX	5.854.200
			63A	125	HDM3E-125M 3P 63A	HDM3E125M6333XX	7.352.400
			100A	125	HDM3E-125M 3P 100A	HDM3E125M10033XX	5.094.100
			125A	125	HDM3E-125M 3P 125A	HDM3E125M12533XX	6.301.900
			160A	160	HDM3E-160M 3P 160A	HDM3E250M16033XX	8.664.700
			250A	160	HDM3E-160M 3P 250A	HDM3E250M25033XX	5.618.800
			400A	400	HDM3E-400M 3P 400A	HDM3E400M40033XX	9.137.700
			630A	630	HDM3E-630M 3P 630A	HDM3E630M63033XX	12.602.700
			800A	630	HDM3E-630M 3P 800A	HDM3E800M80033XX	13.127.400
			1000A	1600	HDM3E-1600M 3P 1000A	HDM3E16M103F555L	57.368.300
			1250A	1600	HDM3E-1600M 3P 1250A	HDM3E16M123F555L	
			1600A	1600	HDM3E-1600M 3P 1600A	HDM3E16M163F555L	66.745.800

## HDM3E MCCB (Electronic Unit) 4 Pole

Product Image	Pole	Icu (kA)	In (A)	Frame Size (AF)	Description	Model	Price
	4P	50KA	32A	125	HDM3E-125M 4P 32A	HDM3E125M32C3XX	6.795.800
			63A	125	HDM3E-125M 4P 63A	HDM3E125M63C3XX	
			100A	125	HDM3E-125M 4P 100A	HDM3E125M100C3XX	
			125A	125	HDM3E-125M 4P 125A	HDM3E125M125C3XX	
			160A	250	HDM3E-250M 4P 160A	HDM3E250M160C3XX	8.487.600
			250A	250	HDM3E-250M 4P 250A	HDM3E250M250C3XX	
			400A	400	HDM3E-400M 4P 400A	HDM3E400M400C3XX	11.135.300
			630A	630	HDM3E-630M 4P 630A	HDM3E630M630C3XX	17.609.900
			800A	800	HDM3E-800M 4P 800A	HDM3E800M800C3XX	18.280.900

# Earth Leakage Circuit Breaker (ELCB)

IEC 60947-2



## HDM3L ELCB 3 Pole



Pole	Icu (kA)	In (A)	Frame Size (AF)	I $\Delta$ n (mA)	Time Delay (s)	Description	Model	Price
3P	50KA	16A	125	30/100/300	No Delay	HDM3L-125F 3P 16A 30/100/300mA NoDelay	HDM3L12F01633X0A0	3.721.300
		20A	125	30/100/300	No Delay	HDM3L-125F 3P 20A 30/100/300mA NoDelay	HDM3L12F02033X0A0	
		25A	125	30/100/300	No Delay	HDM3L-125F 3P 25A 30/100/300mA NoDelay	HDM3L12F02533X0A0	
		32A	125	30/100/300	No Delay	HDM3L-125F 3P 32A 30/100/300mA NoDelay	HDM3L12F03233X0A0	
		40A	125	30/100/300	No Delay	HDM3L-125F 3P 40A 30/100/300mA NoDelay	HDM3L12F04033X0A0	3.578.300
		50A	125	30/100/300	No Delay	HDM3L-125F 3P 50A 30/100/300mA NoDelay	HDM3L12F05033X0A0	
		63A	125	30/100/300	No Delay	HDM3L-125F 3P 63A 30/100/300mA NoDelay	HDM3L12F06333X0A0	
		80A	125	30/100/300	No Delay	HDM3L-125F 3P 80A 30/100/300mA NoDelay	HDM3L12F08033X0A0	
		100A	125	30/100/300	No Delay	HDM3L-125F 3P 100A 30/100/300mA NoDelay	HDM3L12F10033X0A0	3.534.300
		125A	160	30/100/300	No Delay	HDM3L-160F 3P 125A 30/100/300mA NoDelay	HDM3L16F12533X0A0	3.952.300
		140A	160	30/100/300	No Delay	HDM3L-160F 3P 140A 30/100/300mA NoDelay	HDM3L16F14033X0A0	3.927.000
		160A	160	30/100/300	No Delay	HDM3L-160F 3P 160A 30/100/300mA NoDelay	HDM3L16F16033X0A0	3.875.300
		100A	250	30/100/300	No Delay	HDM3L-250F 3P 100A 30/100/300mA NoDelay	HDM3L25F10033X0A0	4.128.300
		125A	250	30/100/300	No Delay	HDM3L-250F 3P 125A 30/100/300mA NoDelay	HDM3L25F12533X0A0	
		140A	250	30/100/300	No Delay	HDM3L-250F 3P 140A 30/100/300mA NoDelay	HDM3L25F14033X0A0	
		160A	250	30/100/300	No Delay	HDM3L-250F 3P 160A 30/100/300mA NoDelay	HDM3L25F16033X0A0	
		180A	250	30/100/300	No Delay	HDM3L-250F 3P 180A 30/100/300mA NoDelay	HDM3L25F18033X0A0	4.130.500
		200A	250	30/100/300	No Delay	HDM3L-250F 3P 200A 30/100/300mA NoDelay	HDM3L25F20033X0A0	
		225A	250	30/100/300	No Delay	HDM3L-250F 3P 225A 30/100/300mA NoDelay	HDM3L25F22533X0A0	
		250A	250	30/100/300	No Delay	HDM3L-250F 3P 250A 30/100/300mA NoDelay	HDM3L25F25033X0A0	

# Earth Leakage Circuit Breaker (ELCB)

IEC 60947-2



## HDM3L ELCB 3 Pole



Pole	Icu (kA)	In (A)	Frame Size (AF)	I $\Delta$ n (mA)	Time Delay (s)	Description	Model	Price
3P	70KA	200A	400	100/300/500	0.1/0.2/0.3	HDM3L-400F 3P 200A 100/300/500mA 0.1/0.2/0.3s	HDM3L40F20033X0B1	7.065.300
		225A	400	100/300/500	0.1/0.2/0.3	HDM3L-400F 3P 225A 100/300/500mA 0.1/0.2/0.3s	HDM3L40F22533X0B1	
		250A	400	100/300/500	0.1/0.2/0.3	HDM3L-400F 3P 250A 100/300/500mA 0.1/0.2/0.3s	HDM3L40F25033X0B1	
		315A	400	100/300/500	0.1/0.2/0.3	HDM3L-400F 3P 315A 100/300/500mA 0.1/0.2/0.3s	HDM3L40F31533X0B1	7.111.500
		350A	400	100/300/500	0.1/0.2/0.3	HDM3L-400F 3P 350A 100/300/500mA 0.1/0.2/0.3s	HDM3L40F35033X0B1	7.076.300
		400A	400	100/300/500	0.1/0.2/0.3	HDM3L-400F 3P 400A 100/300/500mA 0.1/0.2/0.3s	HDM3L40F40033X0B1	7.208.300
		400A	630	100/300/500	0.1/0.3/0.5	HDM3L-630F 3P 400A 100/300/500mA 0.1/0.3/0.5s	HDM3L63F40033X0B3	21.200.300
		500A	630	100/300/500	0.1/0.3/0.5	HDM3L-630F 3P 500A 100/300/500mA 0.1/0.3/0.5s	HDM3L63F50033X0B3	
		630A	630	100/300/500	0.1/0.3/0.5	HDM3L-630F 3P 630A 100/300/500mA 0.1/0.3/0.5s	HDM3L63F63033X0B3	



# Earth Leakage Circuit Breaker (ELCB)

IEC 60947-2



## HDM3L ELCB 4 Pole



Pole	Icu (kA)	In (A)	Frame Size (AF)	I $\Delta$ n (mA)	Time Delay (s)	Description	Model	Price
4P	50KA	16A	125	30/100/300	No Delay	HDM3L-125F 4P 16A 30/100/300mA NoDelay	HDM3L12F016B3X0A0	4.015.000
		20A	125	30/100/300	No Delay	HDM3L-125F 4P 20A 30/100/300mA NoDelay	HDM3L12F020B3X0A0	
		25A	125	30/100/300	No Delay	HDM3L-125F 4P 25A 30/100/300mA NoDelay	HDM3L12F025B3X0A0	
		32A	125	30/100/300	No Delay	HDM3L-125F 4P 32A 30/100/300mA NoDelay	HDM3L12F032B3X0A0	
		40A	125	30/100/300	No Delay	HDM3L-125F 4P 40A 30/100/300mA NoDelay	HDM3L12F040B3X0A0	
		50A	125	30/100/300	No Delay	HDM3L-125F 4P 50A 30/100/300mA NoDelay	HDM3L12F050B3X0A0	
		63A	125	30/100/300	No Delay	HDM3L-125F 4P 63A 30/100/300mA NoDelay	HDM3L12F063B3X0A0	4.037.000
		80A	125	30/100/300	No Delay	HDM3L-125F 4P 80A 30/100/300mA NoDelay	HDM3L12F080B3X0A0	3.971.000
		100A	125	30/100/300	No Delay	HDM3L-125F 4P 100A 30/100/300mA NoDelay	HDM3L12F100B3X0A0	
		125A	160	30/100/300	No Delay	HDM3L-160F 4P 125A 30/100/300mA NoDelay	HDM3L16F125B3X0A0	4.584.800
		140A	160	30/100/300	No Delay	HDM3L-160F 4P 140A 30/100/300mA NoDelay	HDM3L16F140B3X0A0	4.559.500
		160A	160	30/100/300	No Delay	HDM3L-160F 4P 160A 30/100/300mA NoDelay	HDM3L16F160B3X0A0	4.504.500
		100A	250	30/100/300	No Delay	HDM3L-250F 4P 100A 30/100/300mA NoDelay	HDM3L25F100B3X0A0	4.818.000
		125A	250	30/100/300	No Delay	HDM3L-250F 4P 125A 30/100/300mA NoDelay	HDM3L25F125B3X0A0	4.793.800
		140A	250	30/100/300	No Delay	HDM3L-250F 4P 140A 30/100/300mA NoDelay	HDM3L25F140B3X0A0	
		160A	250	30/100/300	No Delay	HDM3L-250F 4P 160A 30/100/300mA NoDelay	HDM3L25F160B3X0A0	
	180A	250	30/100/300	No Delay	HDM3L-250F 4P 180A 30/100/300mA NoDelay	HDM3L25F180B3X0A0		
	200A	250	30/100/300	No Delay	HDM3L-250F 4P 200A 30/100/300mA NoDelay	HDM3L25F200B3X0A0	4.848.800	
	225A	250	30/100/300	No Delay	HDM3L-250F 4P 225A 30/100/300mA NoDelay	HDM3L25F225B3X0A0	4.867.500	
	250A	250	30/100/300	No Delay	HDM3L-250F 4P 250A 30/100/300mA NoDelay	HDM3L25F250B3X0A0	4.840.000	
70KA	200A	400	100/300/500	0.1/0.2/0.3	HDM3L-400F 4P 200A 100/300/500mA 0.1/0.2/0.3s	HDM3L40F200B3X0B1	8.385.300	
	225A	400	100/300/500	0.1/0.2/0.3	HDM3L-400F 4P 225A 100/300/500mA 0.1/0.2/0.3s	HDM3L40F225B3X0B1	8.484.300	
	250A	400	100/300/500	0.1/0.2/0.3	HDM3L-400F 4P 250A 100/300/500mA 0.1/0.2/0.3s	HDM3L40F250B3X0B1		
	315A	400	100/300/500	0.1/0.2/0.3	HDM3L-400F 4P 315A 100/300/500mA 0.1/0.2/0.3s	HDM3L40F315B3X0B1	8.431.500	
	350A	400	100/300/500	0.1/0.2/0.3	HDM3L-400F 4P 350A 100/300/500mA 0.1/0.2/0.3s	HDM3L40F350B3X0B1	8.396.300	
	400A	400	100/300/500	0.1/0.2/0.3	HDM3L-400F 4P 400A 100/300/500mA 0.1/0.2/0.3s	HDM3L40F400B3X0B1	8.547.000	
	400A	630	100/300/500	0.1/0.3/0.5	HDM3L-630F 4P 400A 100/300/500mA 0.1/0.3/0.5s	HDM3L63F400B3X0B3	27.255.800	
	500A	630	100/300/500	0.1/0.3/0.5	HDM3L-630F 4P 500A 100/300/500mA 0.1/0.3/0.5s	HDM3L63F500B3X0B3		
630A	630	100/300/500	0.1/0.3/0.5	HDM3L-630F 4P 630A 100/300/500mA 0.1/0.3/0.5s	HDM3L63F630B3X0B3	27.258.000		

# Air Circuit Breaker (ACB)



HDW3-2000



HDW3-3200



HDW3-4000



HDW3-6000



iTR326A

## HDW3 ACB Fixed 3P/4P (include: MD, CC, SHT, iTR326A)

Pole	Type	Icu (kA)	In (A)	Description	Model	Price	
3P	Fixed	80KA	630A	HDW3-2000M Fixed 3P 630A	HDW320M063FHNN56M	52.000.000	
			800A	HDW3-2000M Fixed 3P 800A	HDW320M083FHNN56M		
			1000A	HDW3-2000M Fixed 3P 1000A	HDW320M103FHNN56M		
			1250A	HDW3-2000M Fixed 3P 1250A	HDW320M123FHNN56M	52.300.000	
			1600A	HDW3-2000M Fixed 3P 1600A	HDW320M163FHNN56M	52.500.000	
			2000A	HDW3-2000M Fixed 3P 2000A	HDW320M203FHNN56M	54.500.000	
		85KA	2500A	2500A	HDW3-3200M Fixed 3P 2500A	HDW332M253FHNN56M	71.632.000
				2500A	HDW3-4000S Fixed 3P 2500A	HDW340S253FHNN54M	96.866.000
				2500A	HDW3-4000M Fixed 3P 2500A	HDW340M253FHNN54M	113.036.000
		100KA	3200A	3200A	HDW3-3200M Fixed 3P 3200A	HDW332M323FHNN56M	71.632.000
				3200A	HDW3-4000M Fixed 3P 3200A	HDW340M323FHNN54M	77.495.000
				4000A	HDW3-4000M Fixed 3P 4000A	HDW340M403FHNN54M	90.937.000
4P	Fixed	80KA	630A	HDW3-2000M Fixed 4P 630A	HDW320M064FHNN56M	59.895.000	
			800A	HDW3-2000M Fixed 4P 800A	HDW320M084FHNN56M		
			1000A	HDW3-2000M Fixed 4P 1000A	HDW320M104FHNN56M		
			1250A	HDW3-2000M Fixed 4P 1250A	HDW320M124FHNN56M	62.370.000	
			1600A	HDW3-2000M Fixed 4P 1600A	HDW320M164FHNN56M		
			2000A	HDW3-2000M Fixed 4P 2000A	HDW320M204FHNN56M		
		85KA	2500A	2500A	HDW3-3200M Fixed 4P 2500A	HDW332M254FHNN56M	80.201.000
				2500A	HDW3-4000S Fixed 4P 2500A	HDW340S254FHNN54M	151.129.000
				2500A	HDW3-4000M Fixed 4P 2500A	HDW340M254FHNN54M	125.312.000
		100KA	3200A	3200A	HDW3-3200M Fixed 4P 3200A	HDW332M324FHNN56M	86.713.000
				3200A	HDW3-4000M Fixed 4P 3200A	HDW340M324FHNN54M	97.262.000
				4000A	HDW3-4000M Fixed 4P 4000A	HDW340M404FHNN54M	105.171.000

# Air Circuit Breaker (ACB)



## HDW3 ACB Draw-Out 3P/4P (include: MD, CC, SHT, iTR326A)

Pole	Type	Icu (kA)	In (A)	Description	Model	Price	
3P	Draw-out	80KA	630A	HDW3-2000M D/O 3P 630A	HDW320M063DHNN56M	72.000.000	
			800A	HDW3-2000M D/O 3P 800A	HDW320M083DHNN56M		
			1000A	HDW3-2000M D/O 3P 1000A	HDW320M103DHNN56M		
			1250A	HDW3-2000M D/O 3P 1250A	HDW320M123DHNN56M	72.300.000	
			1600A	HDW3-2000M D/O 3P 1600A	HDW320M163DHNN56M	72.500.000	
			2000A	HDW3-2000M D/O 3P 2000A	HDW320M203DHNN56M	75.500.000	
		85KA	2500A	2500A	HDW3-3200M D/O 3P 2500A	HDW332M253DHNN56M	108.713.000
				2500A	HDW3-4000S D/O 3P 2500A	HDW340S253DHNN54M	173.327.000
		100KA	3200A	3200A	HDW3-4000M D/O 3P 2500A	HDW340M253DHNN54M	143.803.000
		80KA		3200A	HDW3-3200M D/O 3P 3200A	HDW332M323DHNN56M	117.282.000
		100KA	4000A	4000A	HDW3-4000M D/O 3P 3200A	HDW340M323DHNN54M	145.123.000
				4000A	HDW3-4000M D/O 3P 4000A	HDW340M403DHNN54M	
		120KA	5000A	5000A	HDW3-6300M D/O 3P 5000A	HDW363M503DHNN56M	313.315.200
				6300A	HDW3-6300M D/O 3P 6300A	HDW363M633DHNN56M	360.736.200
4P	Draw-out	80KA	630A	HDW3-2000M D/O 4P 630A	HDW320M064DHNN56M	83.500.000	
			800A	HDW3-2000M D/O 4P 800A	HDW320M084DHNN56M		
			1000A	HDW3-2000M D/O 4P 1000A	HDW320M104DHNN56M		
			1250A	HDW3-2000M D/O 4P 1250A	HDW320M124DHNN56M	83.822.000	
			1600A	HDW3-2000M D/O 4P 1600A	HDW320M164DHNN56M	84.322.000	
			2000A	HDW3-2000M D/O 4P 2000A	HDW320M204DHNN56M	87.285.000	
		85KA	2500A	2500A	HDW3-3200M D/O 4P 2500A	HDW332M254DHNN56M	130.086.000
				2500A	HDW3-4000S D/O 4P 2500A	HDW340S254DHNN54M	192.577.000
		100KA	3200A	3200A	HDW3-4000M D/O 4P 2500A	HDW340M254DHNN54M	159.786.000
		80KA		3200A	HDW3-3200M D/O 4P 3200A	HDW332M324DHNN56M	133.716.000
		100KA	4000A	4000A	HDW3-4000M D/O 4P 3200A	HDW340M324DHNN54M	161.315.000
				4000A	HDW3-4000M D/O 4P 4000A	HDW340M404DHNN54M	
		120KA	5000A	5000A	HDW3-6300M D/O 4P 5000A	HDW363M504DHNN56M	381.986.000
				5000A	HDW3-6300M D/O 4P 5000A	HDW363M504DHNN56M	381.986.000

## Shunt Release (MX)

Product Image	Operating voltage	Description	Model	Price
	AC230V	SHT AC 230V FOR HDW3 (2000/3200/6300AF)	HDW3MX12A	2.608.000
		SHT AC 230V FOR HDW3 (1600AF/4000AF)	HDW3MX2A	
	AC400V	SHT AC 400V FOR HDW3 (2000/3200/6300AF)	HDW3MX13A	
		SHT AC 400V FOR HDW3 (1600AF/4000AF)	HDW3MX3A	
	DC220V	SHT DC220V FOR HDW3 (2000/3200/6300AF)	HDW3MX12D	
		SHT DC220V FOR HDW3 (1600AF/4000AF)	HDW3MX2D	

## Closing Release (XF)

Product Image	Operating voltage	Description	Model	Price
	AC230V	CC AC230V FOR HDW3 (2000/3200/6300AF)	HDW3XF12A	2.608.000
		CC AC230V FOR HDW3 (4000AF)	HDW3XF2A	
	AC400V	CC AC 400V FOR HDW3 (2000/3200/6300AF)	HDW3XF13A	
		CC AC400V FOR HDW3 (4000AF)	HDW3XF3A	
	DC220V	CC DC220V FOR HDW3 (2000/3200/6300AF)	HDW3XF12D	
		CC DC220V FOR HDW3 (4000AF)	HDW3XF2D	

# Air Circuit Breaker (ACB)



## Auxiliary Contact (OF)

Product Image	Contact-Type	Description	Model	Price
	4a4b	OF 4NO+4NC FOR HDW3 (4000AF)	HDW3OF4044	2.628.000
	6a6b	OF 6NO+6NC FOR HDW3 (2000/3200/6300AF)	HDW3OF3266	

## Undervoltage Release (MN)

Product Image	Operating voltage	Description	Model	Price
	AC230V	UVT FOR HDW3 (2000/3200/6300AF)	HDW3MN12A	5.733.000
		UVT FOR HDW3 (1600/4000AF)	HDW3MN2A	
	AC400V	UVT AC400V FOR HDW3 (2000/3200/6300AF)	HDW3MN13A	
		UVT AC400V FOR HDW3 (1600/4000AF)	HDW3MN3A	

## Undervoltage Delayed Release (MNR)

Product Image	Operating voltage	Description	Model	Price
	AC230V	MNR FOR HDW3 (2000/3200/6300AF)	HDW3MNR12A	7.053.000
		MNR FOR HDW3 (1600/4000AF)	HDW3MNR2A	
	AC400V	MNR FOR HDW3 (2000/3200/6300AF)	HDW3MNR13A	
		MNR FOR HDW3 (1600/4000AF)	HDW3MNR3A	

## Key Lock (KL)

Product Image	Lock/key	Description	Model	Price
	1L / 1K	1Key1Lock FOR HDW3(2000/3200/6300AF)	HDW3L1	2.150.000
	2L / 1L	1Key2Lock FOR HDW3(2000/3200/6300AF)	HDW3L2	3.980.000
	3L / 2K	2Key3Lock FOR HDW3(2000/3200/6300AF)	HDW3L3	5.968.000
	3L / 2K	2Key3Lock FOR HDW3(4000AF)	HDW340L3	
	1L / 1K	1Key1Lock FOR HDW3(4000AF)	HDW340L1	2.150.000
	2L / 1K	1Key2Lock FOR HDW3(4000AF)	HDW340L2	3.980.000

# Air Circuit Breaker (ACB)



## Motor Mechanism(MCH)

Product Image	Operating voltage	Description	Model	Price
	AC230V	MCH AC230V FOR HDW3 2000AF	HDW3MCH202A	6.605.000
		MCH AC230V FOR HDW3 3200AF	HDW3MCH322A	
		MCH AC230V FOR HDW3 4000AF	HDW3MCH402A	
		MCH AC230V FOR HDW3 6300AF	HDW3MCH632A	
	AC400V	MCH AC400V FOR HDW3 2000AF	HDW3MCH203A	
		MCH AC400V FOR HDW3 3200AF	HDW3MCH323A	
		MCH AC400V FOR HDW3 4000AF	HDW3MCH403A	
		MCH AC400V FOR HDW3 6300AF	HDW3MCH633A	
	DC220V	MCH DC220V FOR HDW3 2000AF	HDW3MCH202D	
		MCH DC220V FOR HDW3 3200AF	HDW3MCH322D	
		MCH DC220V FOR HDW3 4000AF	HDW3MCH402D	
		MCH DC220V FOR HDW3 6300AF	HDW3MCH632D	

## Mechanical Interlock (MCI)

Product Image	Set	Description	Model	Price
	2 set	MI FOR HDW3-FH (2set) 1600/4000AF	HDW340FL2	9.550.000
		MI FOR HDW3-FH (2set) 2000/3200/6300AF	HDW332FL2	
		MI FOR HDW3-DH (2set) 1600/4000AF	HDW340DL2	
		MI FOR HDW3-DH (2set) 2000/3200/6300AF	HDW332DL2	
	3 set	MI FOR HDW3-FH (3set) 1600/4000AF	HDW340FL3	16.713.000
		MI FOR HDW3-FH (3set) 2000/3200/6300AF	HDW332FL3	
		MI FOR HDW3-DH (3set) 1600/4000AF	HDW340DL3	
		MI FOR HDW3-DH (3set) 2000/3200/6300AF	HDW332DL3	

# Automatic Transfer Switch (ATS)

IEC 60947-6-1



## HDQ3HB ATS 3P

Product Image	Pole	Icu (kA)	Rated Current	Frame size	Description	Model	Price
	3P	25KA	100A	100AF	HDQ3HB-100S 3P 100A	HDQ3HB100S1003	14.286.800
			50KA	125A	250AF	HDQ3HB-250F 3P 125A	HDQ3HB250F1253
		160A		250AF	HDQ3HB-250F 3P 160A	HDQ3HB250F1603	
		200A		250AF	HDQ3HB-250F 3P 200A	HDQ3HB250F2003	
		225A		250AF	HDQ3HB-250F 3P 225A	HDQ3HB250F2253	
		250A		250AF	HDQ3HB-250F 3P 250A	HDQ3HB250F2503	27.599.000
		315A		400AF	HDQ3HB-400F 3P 315A	HDQ3HB400F3153	
		350A		400AF	HDQ3HB-400F 3P 350A	HDQ3HB400F3503	
		400A		400AF	HDQ3HB-400F 3P 400A	HDQ3HB400F4003	
		500A	630AF	HDQ3HB-400F 3P 500A	HDQ3HB630F5003	30.330.300	
630A	630AF	HDQ3HB-400F 3P 630A	HDQ3HB630F6303				

## HDQ3HB ATS 4P

Product Image	Pole	Icu (kA)	Rated Current	Frame Size	Description	Model	Price
	4P	25KA	100A	100AF	HDQ3HB-100S 4P 100A	HDQ3HB100S1004	14.795.000
			50KA	125A	250AF	HDQ3HB-250F 4P 125A	HDQ3HB250F1254
		160A		250AF	HDQ3HB-250F 4P 160A	HDQ3HB250F1604	
		180A		250AF	HDQ3HB-250F 4P 180A	HDQ3HB250F1804	
		200A		250AF	HDQ3HB-250F 4P 200A	HDQ3HB250F2004	
		225A		250AF	HDQ3HB-250F 4P 225A	HDQ3HB250F2254	31.540.300
		250A		250AF	HDQ3HB-250F 4P 250A	HDQ3HB250F2504	
		315A		400AF	HDQ3HB-400F 4P 315A	HDQ3HB400F3154	
		350A		400AF	HDQ3HB-400F 4P 350A	HDQ3HB400F3504	
		400A	400AF	HDQ3HB-400F 4P 400A	HDQ3HB400F4004	33.375.100	
500A	630AF	HDQ3HB-630F 4P 500A	HDQ3HB630F5004				
630A	630AF	HDQ3HB-630F 4P 630A	HDQ3HB630F6304				

# Magnetic Contactor

IEC 60947-4



## HDC3 Magnetic Contactor 50Hz, 50/60Hz



Current (A)	Coil Open Rating Voltage (V)	Contact	Coil Frequency (Hz)	Description	Model	Price
6A	24V	1NO	50Hz/60Hz	HDC3-6A/24V 1NO 50/60Hz	HDC30610B7	235.000
	110V		50Hz/60Hz	HDC3-6A/110V 1NO 50/60Hz	HDC30610F7	
	220V/230V		50Hz/60Hz	HDC3-6A/220-230V 1NO 50/60Hz	HDC30610M7	
	380V/400V		50Hz/60Hz	HDC3-6A/380-400V 1NO 50/60Hz	HDC30610Q7	
9A	24V	1NO+1NC	50Hz/60Hz	HDC3-9A/24V 1NO+1NC 50/60Hz	HDC30911B7	240.300
	110V		50Hz/60Hz	HDC3-9A/110V 1NO+1NC 50/60Hz	HDC30911F7	
	220V/230V		50Hz/60Hz	HDC3-9A/220-230V 1NO+1NC 50/60Hz	HDC30911M7	
	380V/400V		50Hz/60Hz	HDC3-9A/380-400V 1NO+1NC 50/60Hz	HDC30911Q7	
12A	24V	1NO+1NC	50Hz/60Hz	HDC3-12A/24V 1NO+1NC 50/60Hz	HDC31211B7	265.000
	110V		50Hz/60Hz	HDC3-12A/110V 1NO+1NC 50/60Hz	HDC31211F7	
	220V/230V		50Hz/60Hz	HDC3-12A/220-230V 1NO+1NC 50/60Hz	HDC31211M7	
	380V/400V		50Hz/60Hz	HDC3-12A/380-400V 1NO+1NC 50/60Hz	HDC31211Q7	
18A	24V	1NO+1NC	50Hz/60Hz	HDC3-18A/24V 1NO+1NC 50/60Hz	HDC31811B7	316.800
	110V		50Hz/60Hz	HDC3-18A/110V 1NO+1NC 50/60Hz	HDC31811F7	
	220V/230V		50Hz/60Hz	HDC3-18A/220-230V 1NO+1NC 50/60Hz	HDC31811M7	
	380V/400V		50Hz/60Hz	HDC3-18A/380-400V 1NO+1NC 50/60Hz	HDC31811Q7	
25A	24V	1NO+1NC	50Hz/60Hz	HDC3-25A/24V 1NO+1NC 50/60Hz	HDC32511B7	415.000
	110V		50Hz/60Hz	HDC3-25A/110V 1NO+1NC 50/60Hz	HDC32511F7	
	220V/230V		50Hz/60Hz	HDC3-25A/220-230V 1NO+1NC 50/60Hz	HDC32511M7	
	380V/400V		50Hz/60Hz	HDC3-25A/380-400V 1NO+1NC 50/60Hz	HDC32511Q7	
32A	24V	1NO+1NC	50Hz/60Hz	HDC3-32A/24V 1NO+1NC 50/60Hz	HDC33211B7	570.000
	110V		50Hz/60Hz	HDC3-32A/110V 1NO+1NC 50/60Hz	HDC33211F7	
	220V/230V		50Hz/60Hz	HDC3-32A/220-230V 1NO+1NC 50/60Hz	HDC33211M7	
	380V/400V		50Hz/60Hz	HDC3-32A/380-400V 1NO+1NC 50/60Hz	HDC33211Q7	
38A	24V	1NO+1NC	50Hz/60Hz	HDC3-38A/24V 1NO+1NC 50/60Hz	HDC33811B7	595.000
	110V		50Hz/60Hz	HDC3-38A/110V 1NO+1NC 50/60Hz	HDC33811F7	
	220V/230V		50Hz/60Hz	HDC3-38A/220-230V 1NO+1NC 50/60Hz	HDC33811M7	
	380V/400V		50Hz/60Hz	HDC3-38A/380-400V 1NO+1NC 50/60Hz	HDC33811Q7	

# Magnetic Contactor

IEC 60947-4



Current (A)	Coil Open Rating Voltage (V)	Contact	Coil Frequency (Hz)	Description	Model	Price
40A	24V	1NO+1NC	50Hz/60Hz	HDC3-40A/24V 1NO+1NC 50/60Hz	HDC34011B7	982.300
	110V		50Hz/60Hz	HDC3-40A/110V 1NO+1NC 50/60Hz	HDC34011F7	
	220V/230V		50Hz/60Hz	HDC3-40A/220-230V 1NO+1NC 50/60Hz	HDC34011M7	
	380V/400V		50Hz/60Hz	HDC3-40A/380-400V 1NO+1NC 50/60Hz	HDC34011Q7	
50A	24V		50Hz/60Hz	HDC3-50A/24V 1NO+1NC 50/60Hz	HDC35011B7	1.050.000
	110V		50Hz/60Hz	HDC3-50A/110V 1NO+1NC 50/60Hz	HDC35011F7	
	220V/230V		50Hz/60Hz	HDC3-50A/220-230V 1NO+1NC 50/60Hz	HDC35011M7	
	380V/400V		50Hz/60Hz	HDC3-50A/380-400V 1NO+1NC 50/60Hz	HDC35011Q7	
65A	24V		50Hz/60Hz	HDC3-65A/24V 1NO+1NC 50/60Hz	HDC36511B7	1.150.000
	110V		50Hz/60Hz	HDC3-65A/110V 1NO+1NC 50/60Hz	HDC36511F7	
	220V/230V		50Hz/60Hz	HDC3-65A/220-230V 1NO+1NC 50/60Hz	HDC36511M7	
	380V/400V		50Hz/60Hz	HDC3-65A/380-400V 1NO+1NC 50/60Hz	HDC36511Q7	
80A	24V		50Hz/60Hz	HDC3-80A/24V 1NO+1NC 50/60Hz	HDC38011B7	1.748.000
	110V		50Hz/60Hz	HDC3-80A/110V 1NO+1NC 50/60Hz	HDC38011F7	
	220V/230V		50Hz/60Hz	HDC3-80A/220-230V 1NO+1NC 50/60Hz	HDC38011M7	
	380V/400V		50Hz/60Hz	HDC3-80A/380-400V 1NO+1NC 50/60Hz	HDC38011Q7	
95A	24V	50Hz/60Hz	HDC3-95A/24V 1NO+1NC 50/60Hz	HDC39511B7	1.950.000	
	110V	50Hz/60Hz	HDC3-95A/110V 1NO+1NC 50/60Hz	HDC39511F7		
	220V/230V	50Hz/60Hz	HDC3-95A/220-230V 1NO+1NC 50/60Hz	HDC39511M7		
	380V/400V	50Hz/60Hz	HDC3-95A/380-400V 1NO+1NC 50/60Hz	HDC39511Q7		
120A	AC 110V	50Hz	HDC3-120A/110V 2NO+2NC 50Hz	HDC3120F	4.800.000	
	AC 220V	50Hz	HDC3-120A/220V 2NO+2NC 50Hz	HDC3120M		
	AC 380V	50Hz	HDC3-120A/380V 2NO+2NC 50Hz	HDC3120Q		
160A	AC 110V	50Hz	HDC3-160A/110V 2NO+2NC 50Hz	HDC3160F	4.860.000	
	AC 220V	50Hz	HDC3-160A/220V 2NO+2NC 50Hz	HDC3160M		
	AC 380V	50Hz	HDC3-160A/380V 2NO+2NC 50Hz	HDC3160Q		
185A	AC 110V	50Hz	HDC3-180A/110V 2NO+2NC 50Hz	HDC3185F	5.300.000	
	AC 220V	50Hz	HDC3-180A/220V 2NO+2NC 50Hz	HDC3185M		
	AC 380V	50Hz	HDC3-180A/380V 2NO+2NC 50Hz	HDC3185Q		
225A	AC 110V	50Hz	HDC3-225A/110V 2NO+2NC 50Hz	HDC3225F	5.260.000	
	AC 220V	50Hz	HDC3-225A/220V 2NO+2NC 50Hz	HDC3225M		
	AC 380V	50Hz	HDC3-225A/380V 2NO+2NC 50Hz	HDC3225Q		
265A	AC/DC 100-250V	50Hz/60Hz	HDC3-265A AC/DC 100-250V 2NO+2NC 50/60Hz	HDC3265KUE7	10.500.000	
330A	AC/DC 100-250V	50Hz/60Hz	HDC3-330A AC/DC 100-250V 2NO+2NC 50/60Hz	HDC3330KUE7	11.500.000	
400A	AC/DC 100-250V	50Hz/60Hz	HDC3-400A AC/DC 100-250V 2NO+2NC 50/60Hz	HDC3400KUE7	12.000.000	
500A	AC/DC 100-250V	50Hz/60Hz	HDC3-500A AC/DC 100-250V 2NO+2NC 50/60Hz	HDC3500KUE7	18.000.000	
630A	AC/DC 100-250V	50Hz/60Hz	HDC3-630A AC/DC 100-250V 2NO+2NC 50/60Hz	HDC3630KUE7	19.000.000	



# Magnetic Starter

IEC 60947-4



## HDS3 Magnetic Starter 50/60Hz



Current	Frame Size	Coil Open Rating Voltage (V)	Hz	Material	TOR setting current	Description	Model	Price
9A	18	220V/ 230V	50/ 60Hz	Metal	0.63 - 1A	HDS3-18/9A 220-230V 1A 50Hz/60Hz Metal	HDS318B09M701M	1.257.300
					2.5 - 4.0A	HDS3-18/9A 220-230V 4A 50Hz/60Hz Metal	HDS318B09M704M	
					4.0 - 6A	HDS3-18/9A 220-230V 6A 50Hz/60Hz Metal	HDS318B09M706M	
					5.5 - 8A	HDS3-18/9A 220-230V 8A 50Hz/60Hz Metal	HDS318B09M708M	
					1.0 - 1.6A	HDS3-18/9A 220-230V 1.6A 50Hz/60Hz Metal	HDS318B09M71P6M	
					1.6 - 2.5A	HDS3-18/9A 220-230V 2.5A 50Hz/60Hz Metal	HDS318B09M72P5M	
					0.1 - 0.16A	HDS3-18/9A 220-230V 0.16A 50Hz/60Hz Metal	HDS318B09M7P16M	
					0.16 - 0.25A	HDS3-18/9A 220-230V 0.25A 50Hz/60Hz Metal	HDS318B09M7P25M	
					0.25 - 0.4A	HDS3-18/9A 220-230V 0.4A 50Hz/60Hz Metal	HDS318B09M7P4M	
					0.4 - 0.63A	HDS3-18/9A 220-230V 0.63A 50Hz/60Hz Metal	HDS318B09M7P63M	
12A	18	220V/ 230V	50/ 60Hz	Metal	7.0 - 10A	HDS3-18/12A 220-230V 10A 50Hz/60Hz Metal	HDS318B12M710M	1.257.300
18A					9.0 - 13A	HDS3-18/18A 220-230V 13A 50Hz/60Hz Metal	HDS318B18M713M	
9A	38	220V/ 230V	50/ 60Hz	Plastic	0.1 - 0.16A	HDS3-38/9A 220-230V 0.16A 50Hz/60Hz Plastic	HDS338B09M7P16	1.378.300
					0.16 - 0.25A	HDS3-38/9A 220-230V 0.25A 50Hz/60Hz Plastic	HDS338B09M7P25	

# Magnetic Starter

IEC 60947-4



Current	Frame Size	Coil Open Rating Voltage (V)	Hz	Material	TOR setting current	Description	Model	Price					
9A	38	220V/ 230V	50/ 60Hz	Plastic	0.25 - 0.4A	HDS3-38/9A 220-230V 0.4A 50Hz/60Hz Plastic	HDS338B09M7P4	1.378.300					
					0.4 - 0.63A	HDS3-38/9A 220-230V 0.63A 50Hz/60Hz Plastic	HDS338B09M7P63						
					0.63 - 1A	HDS3-38/9A 220-230V 1A 50Hz/60Hz Plastic	HDS338B09M701						
					1.0 - 1.6A	HDS3-38/9A 220-230V 1.6A 50Hz/60Hz Plastic	HDS338B09M71P6						
					1.6 - 2.5A	HDS3-38/9A 220-230V 2.5A 50Hz/60Hz Plastic	HDS338B09M72P5						
					2.5 - 4.0A	HDS3-38/9A 220-230V 4A 50Hz/60Hz Plastic	HDS338B09M704						
					4.0 - 6A	HDS3-38/9A 220-230V 6A 50Hz/60Hz Plastic	HDS338B09M706						
					5.5 - 8A	HDS3-38/9A 220-230V 8A 50Hz/60Hz Plastic	HDS338B09M708						
12A	38	220V/ 230V	50/ 60Hz	Plastic	7.0 - 10A	HDS3-38/12A 220-230V 10A 50Hz/60Hz Plastic	HDS338B12M710	1.732.500					
18A					9.0 - 13A	HDS3-38/18A 220-230V 13A 50Hz/60Hz Plastic	HDS338B18M713						
25A					12 - 18A	HDS3-38/25A 220-230V 18A 50Hz/60Hz Plastic	HDS338B25M718						
32A					23-32A	HDS3-38/32A 220-230V 32A 50Hz/60Hz Plastic	HDS338B32M732						
38A					30-40A	HDS3-38/38A 220-230V 40A 50Hz/60Hz Plastic	HDS338B38M740						
40A					30-40A	HDS3-95/40A 220-230V 40A 50Hz/60Hz Plastic	HDS395B40M740		2.970.000				
50A					95	220V/ 230V	50/ 60Hz		Plastic	37-50A	HDS3-95/50A 220-230V 50A 50Hz/60Hz Plastic	HDS395B50M750	3.275.800
65A										48-65A	HDS3-95/65A 220-230V 65A 50Hz/60Hz Plastic	HDS395B65M765	
80A	63-80A	HDS3-95/80A 220-230V 80A 50Hz/60Hz Plastic	HDS395B80M780	4.320.800									
95A	80-93A	HDS3-95/95A 220-230V 93A 50Hz/60Hz Plastic	HDS395B95M793										

# Magnetic Contactor Accessories

## Accessories for Magnetic Contactor

Product Image	ACC Name	Range	Contact	Pole	Description	Model	Price
	T-AUX	06-95A	1NO+1NC	2P	Top of auxiliary contact 2P FOR MC 06-95A	HF411	115.000
		06-95A	2NO+2NC	4P	Top of auxiliary contact 4P FOR MC 06-95A	HF422	205.000
	S-AUX	120-630A	1NO+1NC	2P	Side of auxiliary contact 2P FOR MC 120-630A	HC411	195.800
		06-95A	1NO+1NC	2P	Side of auxiliary contact 2P FOR MC 06-95A	HFC611	205.000
	MTD	-	1NO+1NC	-	Making time delay 1NO 1NC	HFT620	701.800
		-	1NO+1NC	-	Making time delay 1NO 1NC	HFT622	
		-	1NO+1NC	-	Making time delay 1NO 1NC	HFT624	
	BTD	-	1NO+1NC	-	Breaking time delay 1NO 1NC	HFT630	
		-	1NO+1NC	-	Breaking time delay 1NO 1NC	HFT632	
		-	1NO+1NC	-	Breaking time delay 1NO 1NC	HFT634	
	MI	09-38A	-	-	Mechanical Interlocking (Horizontal) FOR 09-38A	HFR632H	492.800
		40-95A	-	-	Mechanical Interlocking (Horizontal) FOR 40-95A	HFR695H	652.300
		120-225A	-	-	Mechanical interlock FOR MC 120-225A	HFR4225	492.800
		265-400A	-	-	Mechanical interlock FOR MC 265-400A	HFR4400	
		500-630A	-	-	Mechanical interlock FOR MC 500-630A	HFR4630	

# Thermal Overload Relay (TOR)

IEC 60947-4



## HDR3STOR

Product Image	Frame Size (AF)	Setting Current	Description	Model	Price
	25	0.1 - 0.16A	HDR3s-25 0.16A	HDR3S25P16	268.400
		0.16 - 0.25A	HDR3s-25 0.25A	HDR3S25P25	
		0.25 - 0.4A	HDR3s-25 0.4A	HDR3S25P4	
		0.4 - 0.63A	HDR3s-25 0.63A	HDR3S25P63	
		0.63 - 1.0A	HDR3s-25 1A	HDR3S251	
		1.0 - 1.6A	HDR3s-25 1.6A	HDR3S251P6	
		1.6 - 2.5A	HDR3s-25 2.5A	HDR3S252P5	
		2.5 - 4.0A	HDR3s-25 4.0A	HDR3S254	
		4.0 - 6A	HDR3s-25 6A	HDR3S256	
		5.5 - 8A	HDR3s-25 8A	HDR3S258	
		7.0 - 10A	HDR3s-25 10A	HDR3S2510	
		9.0 - 13A	HDR3s-25 13A	HDR3S2513	
		12 - 18A	HDR3s-25 18A	HDR3S2518	
	17 - 25A	HDR3s-25 25A	HDR3S2525		
	38	23-32A	HDR3s-38 32A	HDR3S3832	391.500
		30-40A	HDR3s-38 40A	HDR3S3840	
	93	7.0-10A	HDR3s-93 10A	HDR3S9310	621.000
		9.0-13A	HDR3s-93 13A	HDR3S9313	
		12-18A	HDR3s-93 18A	HDR3S9318	
		17-25A	HDR3s-93 25A	HDR3S9325	
		23-32A	HDR3s-93 32A	HDR3S9332	
		30-40A	HDR3s-93 40A	HDR3S9340	
		37-50A	HDR3s-93 50A	HDR3S9350	
		48-65A	HDR3s-93 65A	HDR3S9365	
		55-70A	HDR3s-93 70A	HDR3S9370	
	185	63-80A	HDR3s-93 80A	HDR3S9380	2.800.000
		80-93A	HDR3s-93 93A	HDR3S9393	
		48-65A	HDR3s-185 65A	HDR3S18565	
		55-70A	HDR3s-185 70A	HDR3S18570	
		63-80A	HDR3s-185 80A	HDR3S18580	
		75-95A	HDR3s-185 95A	HDR3S18595	
		90-115A	HDR3s-185 115A	HDR3S185115	
		105-135A	HDR3s-185 135A	HDR3S185135	
630	120-150A	HDR3s-185 150A	HDR3S185150	5.940.000	
	130-160A	HDR3s-185 160A	HDR3S185160		
	150-185A	HDR3s-185 185A	HDR3S185185		
	145-200A	HDR3s-630 200A	HDR3S630200F		
	180-250A	HDR3s-630 250A	HDR3S630250F		
	230-320A	HDR3s-630 320A	HDR3S630320F		
290-400A	HDR3s-630 400A	HDR3S630400F			
350-480A	HDR3s-630 480A	HDR3S630480F			
460-630A	HDR3s-630 630A	HDR3S630630F			

## HJRS Base for TOR

Frame Size (AF)	Setting Current	Description	Model	Price
25	Base	HJRS1D Base forTOR 25AF	HJRS1D25J	126.500
36	Base	HJRS1D Base forTOR 36AF	HJRS1D36J	212.300
93	Base	HJRS1D Base forTOR 93AF	HJRS1D93J	379.500

# Surge Protective Device (SPD)

IEC 61643-11



## HDY3N SPD Class II(8/20us) 385V



Pole	In (kA)	I <sub>max</sub> (kA)	U <sub>c</sub> (V)	Description	Model	Price
1P+N	10kA	20kA	AC 385V	HDY3N 8/20us 1P+N 385V 20kA	HDY3N205	908.160
	20kA	40kA		HDY3N 8/20us 1P+N 385V 40kA	HDY3N405	947.760
	35kA	65kA		HDY3N 8/20us 1P+N 385V 65kA	HDY3N655	1.141.800
	40kA	80kA		HDY3N 8/20us 1P+N 385V 80kA	HDY3N805	1.848.000
	60kA	120kA		HDY3N 8/20us 1P+N 385V 120kA	HDY3N1205	2.237.400
	80kA	160kA		HDY3N 8/20us 1P+N 385V 160kA	HDY3N1605	3.352.800
1P	10kA	20kA		HDY3N 8/20us 1P 385V 20kA	HDY3N201	340.560
	20kA	40kA		HDY3N 8/20us 1P 385V 40kA	HDY3N401	382.800
	35kA	65kA		HDY3N 8/20us 1P 385V 65kA	HDY3N651	578.160
	40kA	80kA		HDY3N 8/20us 1P 385V 80kA	HDY3N801	743.160
	60kA	120kA		HDY3N 8/20us 1P 385V 120kA	HDY3N1201	1.132.560
	80kA	160kA		HDY3N 8/20us 1P 385V 160kA	HDY3N1601	1.686.960
2P	10kA	20kA		HDY3N 8/20us 2P 385V 20kA	HDY3N202	663.960
	20kA	40kA		HDY3N 8/20us 2P 385V 40kA	HDY3N402	743.160
	35kA	65kA		HDY3N 8/20us 2P 385V 65kA	HDY3N652	1.135.200
	40kA	80kA		HDY3N 8/20us 2P 385V 80kA	HDY3N802	1.429.560
	60kA	120kA		HDY3N 8/20us 2P 385V 120kA	HDY3N1202	2.118.600
	80kA	160kA		HDY3N 8/20us 2P 385V 160kA	HDY3N1602	3.313.200
3P	10kA	20kA		HDY3N 8/20us 3P 385V 20kA	HDY3N203	976.800
	20kA	40kA		HDY3N 8/20us 3P 385V 40kA	HDY3N403	1.095.600
	35kA	65kA		HDY3N 8/20us 3P 385V 65kA	HDY3N653	1.680.360
	40kA	80kA		HDY3N 8/20us 3P 385V 80kA	HDY3N803	2.122.560
	60kA	120kA		HDY3N 8/20us 3P 385V 120kA	HDY3N1203	3.293.400
	80kA	160kA		HDY3N 8/20us 3P 385V 160kA	HDY3N1603	4.960.560
4P	10kA	20kA	HDY3N 8/20us 4P 385V 20kA	HDY3N204	1.290.960	
	20kA	40kA	HDY3N 8/20us 4P 385V 40kA	HDY3N404	1.449.360	
	35kA	65kA	HDY3N 8/20us 4P 385V 65kA	HDY3N654	2.228.160	
	40kA	80kA	HDY3N 8/20us 4P 385V 80kA	HDY3N804	2.775.960	
	60kA	120kA	HDY3N 8/20us 4P 385V 120kA	HDY3N1204	4.340.160	
	80kA	160kA	HDY3N 8/20us 4P 385V 160kA	HDY3N1604	6.600.000	
3P+N	10kA	20kA	HDY3N 8/20us 3P+N 385V 20kA	HDY3N206	1.524.600	
	20kA	40kA	HDY3N 8/20us 3P+N 385V 40kA	HDY3N406	1.643.400	
	35kA	65kA	HDY3N 8/20us 3P+N 385V 65kA	HDY3N656	2.228.160	
	40kA	80kA	HDY3N 8/20us 3P+N 385V 80kA	HDY3N806	3.194.400	
	60kA	120kA	HDY3N 8/20us 3P+N 385V 120kA	HDY3N1206	4.366.560	
	80kA	160kA	HDY3N 8/20us 3P+N 385V 160kA	HDY3N1606	6.639.600	

# Surge Protective Device (SPD)

IEC 61643-11



## HDY3N SPD Class II(8/20us) 275V



Pole	In (kA)	I <sub>max</sub> (kA)	U <sub>c</sub> (V)	Description	Model	Price
1P+N	10kA	20kA	AC 275V	HDY3N 8/20us 1P+N 275V 20kA	HDY3N205275	908.160
	20kA	40kA		HDY3N 8/20us 1P+N 275V 40kA	HDY3N405275	947.760
	35kA	65kA		HDY3N 8/20us 1P+N 275V 65kA	HDY3N655275	1.141.800
	40kA	80kA		HDY3N 8/20us 1P+N 275V 80kA	HDY3N805275	1.848.000
	60kA	120kA		HDY3N 8/20us 1P+N 275V 120kA	HDY3N1205275	2.237.400
	80kA	160kA		HDY3N 8/20us 1P+N 275V 160kA	HDY3N1605275	3.352.800
	1P	10kA		20kA	HDY3N 8/20us 1P 275V 20kA	HDY3N201275
20kA		40kA		HDY3N 8/20us 1P 275V 40kA	HDY3N401275	382.800
35kA		65kA		HDY3N 8/20us 1P 275V 65kA	HDY3N651275	574.200
40kA		80kA		HDY3N 8/20us 1P 275V 80kA	HDY3N801275	743.160
60kA		120kA		HDY3N 8/20us 1P 275V 120kA	HDY3N1201275	1.132.560
80kA		160kA		HDY3N 8/20us 1P 275V 160kA	HDY3N1601275	1.686.960
2P		10kA		20kA	HDY3N 8/20us 2P 275V 20kA	HDY3N202275
	20kA	40kA		HDY3N 8/20us 2P 275V 40kA	HDY3N402275	743.160
	35kA	65kA		HDY3N 8/20us 2P 275V 65kA	HDY3N652275	1.135.200
	40kA	80kA		HDY3N 8/20us 2P 275V 80kA	HDY3N802275	1.429.560
	60kA	120kA		HDY3N 8/20us 2P 275V 120kA	HDY3N1202275	2.211.000
	80kA	160kA		HDY3N 8/20us 2P 275V 160kA	HDY3N1602275	3.313.200
	3P	10kA		20kA	HDY3N 8/20us 3P 275V 20kA	HDY3N203275
20kA		40kA		HDY3N 8/20us 3P 275V 40kA	HDY3N403275	1.095.600
35kA		65kA		HDY3N 8/20us 3P 275V 65kA	HDY3N653275	1.680.360
40kA		80kA		HDY3N 8/20us 3P 275V 80kA	HDY3N803275	2.122.560
60kA		120kA		HDY3N 8/20us 3P 275V 120kA	HDY3N1203275	3.293.400
80kA		160kA		HDY3N 8/20us 3P 275V 160kA	HDY3N1603275	4.960.560
4P		10kA		20kA	HDY3N 8/20us 4P 275V 20kA	HDY3N204275
	20kA	40kA		HDY3N 8/20us 4P 275V 40kA	HDY3N404275	1.449.360
	35kA	65kA		HDY3N 8/20us 4P 275V 65kA	HDY3N654275	2.228.160
	40kA	80kA		HDY3N 8/20us 4P 275V 80kA	HDY3N804275	2.775.960
	60kA	120kA	HDY3N 8/20us 4P 275V 120kA	HDY3N1204275	4.340.160	
	80kA	160kA	HDY3N 8/20us 4P 275V 160kA	HDY3N1604275	6.600.000	
	3P+N	10kA	20kA	HDY3N 8/20us 3P+N 275V 20kA	HDY3N206275	1.524.600
20kA		40kA	HDY3N 8/20us 3P+N 275V 40kA	HDY3N406275	1.643.400	
35kA		65kA	HDY3N 8/20us 3P+N 275V 65kA	HDY3N656275	2.228.160	
40kA		80kA	HDY3N 8/20us 3P+N 275V 80kA	HDY3N806275	3.194.400	
60kA		120kA	HDY3N 8/20us 3P+N 275V 120kA	HDY3N1206275	4.366.560	
80kA		160kA	HDY3N 8/20us 3P+N 275V 160kA	HDY3N1606275	6.639.600	

# Distribution Box

IEC/EN 60670



## HDPZ Distribution Box



Number of Ways	Installation	IP Grade	Fire-retardancy	Description	Model	Price
4 Ways	Flush Install	IP30	Fire-retardancy	HDPZ50 4ways Flush install IP30 Fire-retardancy	HDPZ50PR4IP30F	308.000
6 Ways				HDPZ50 6ways Flush install IP30 Fire-retardancy	HDPZ50PR6IP30F	385.000
8 Ways				HDPZ50 6ways Flush install IP30 Fire-retardancy	HDPZ50PR8IP30F	459.800
12 Ways				HDPZ50 12ways Flush install IP30 Fire-retardancy	HDPZ50PR12IP30F	531.300
15 Ways				HDPZ50 15ways Flush install IP30 Fire-retardancy	HDPZ50PR15IP30F	891.000
18 Ways				HDPZ50 18ways Flush install IP30 Fire-retardancy	HDPZ50PR18IP30F	1.053.800
24 Ways				HDPZ50 24ways Flush install IP30 Fire-retardancy	HDPZ50PR24IP30F	1.512.500
36 Ways				HDPZ50 36ways Flush install IP30 Fire-retardancy	HDPZ50PR36IP30F	2.178.000

# Fuse

IEC 60269



## HRT16 Fuse

Product Image	In(A)	Size	Type	Description	Model	Price	
	2A	Size-00	Blade	HRT-16 Blade Fuse 00 2A	HRT16002	140.800	
	4A			HRT-16 Blade Fuse 00 4A	HRT16004		
	6A			HRT-16 Blade Fuse 00 6A	HRT16006		
	8A			HRT-16 Blade Fuse 00 8A	HRT16008		
	10A			HRT-16 Blade Fuse 00 10A	HRT160010		
	12A			HRT-16 Blade Fuse 00 12A	HRT160012		
	16A			HRT-16 Blade Fuse 00 16A	HRT160016		
	20A			HRT-16 Blade Fuse 00 20A	HRT160020		
	25A			HRT-16 Blade Fuse 00 25A	HRT160025		
	32A			HRT-16 Blade Fuse 00 32A	HRT160032		
	40A			HRT-16 Blade Fuse 00 40A	HRT160040		
	50A			HRT-16 Blade Fuse 00 50A	HRT160050		
	63A			HRT-16 Blade Fuse 00 63A	HRT160063		
	80A			HRT-16 Blade Fuse 00 80A	HRT160080		
	100A			HRT-16 Blade Fuse 00 100A	HRT1600100		170.500
	125A			HRT-16 Blade Fuse 00 125A	HRT1600125		140.800
	160A			HRT-16 Blade Fuse 00 160A	HRT1600160		170.500

## HRT18 Fuse

Product Image	In(A)	Size	Type	Description	Model	Price		
	2A	10 x 38	Cylinder	HRT-18 Cyliner Fuse 10x38 2A	HRT1810382	14.300		
	4A			HRT-18 Cyliner Fuse 10x38 4A	HRT1810384			
	6A			HRT-18 Cyliner Fuse 10x38 6A	HRT1810386			
	8A			HRT-18 Cyliner Fuse 10x38 8A	HRT1810388			
	10A			HRT-18 Cyliner Fuse 10x38 10A	HRT18103810			
	12A			HRT-18 Cyliner Fuse 10x38 12A	HRT18103812			
	16A			HRT-18 Cyliner Fuse 10x38 16A	HRT18103816			
	20A			HRT-18 Cyliner Fuse 10x38 20A	HRT18103820			
	25A			HRT-18 Cyliner Fuse 10x38 25A	HRT18103825			
	32A			HRT-18 Cyliner Fuse 10x38 32A	HRT18103832			
	2A			14 x 51	HRT-18 Cyliner Fuse 14x51 2A		HRT1814512	27.500
	4A				HRT-18 Cyliner Fuse 14x51 4A		HRT1814514	
	6A				HRT-18 Cyliner Fuse 14x51 6A		HRT1814516	
	8A	HRT-18 Cyliner Fuse 14x51 8A			HRT1814518			
	10A	HRT-18 Cyliner Fuse 14x51 10A			HRT18145110			
	12A	HRT-18 Cyliner Fuse 14x51 12A			HRT18145112			
	16A	HRT-18 Cyliner Fuse 14x51 16A			HRT18145116			
	20A	HRT-18 Cyliner Fuse 14x51 20A			HRT18145120			
	25A	HRT-18 Cyliner Fuse 14x51 25A			HRT18145125			
	32A	HRT-18 Cyliner Fuse 14x51 32A			HRT18145132			
	40A	HRT-18 Cyliner Fuse 14x51 40A			HRT18145140			
	50A	HRT-18 Cyliner Fuse 14x51 50A			HRT18145150			
	63A	HRT-18 Cyliner Fuse 14x51 63A			HRT18145163			

## HRT18 Fuse Holder

Product Image	Rating	Pole	Material	Indicator	Description	Model	Price
	32A holder	2P	Resin	With Indicator	HRT18-32 Holder 2P Resin/with indicator	HRT1832Z2XB	140.800
	63A holder	2P			HRT18-63 Holder 2P Resin/with indicator	HRT1863Z2XB	283.800
	160A holder	-		-	HRT18-160 Holder Resin material	HRT1600ZS	159.500



# Inverter



HAVBA



HAVXS



HAVSP

## HAVBA Basic Inverter

Type	Input	Power Range	Description	Model	Price
Basic	1Phase - 220V	0.4KW	HAVBA 220V-Singe phase 0.4kw	HAVBA2S0004G	5.005.000
		0.75KW	HAVBA 220V-Singe phase 0.75kw	HAVBA2S0007G	
		1.5KW	HAVBA 220V-Singe phase 1.5kw	HAVBA2S0015G	5.192.000
		2.2KW	HAVBA 220V-Singe phase 2.2kw	HAVBA2S0022G	7.741.800
	3Phase - 220V	0.75KW	HAVBA 220V-Three phase 1.5kw	HAVBA2T0007G	6.542.800
		1.5KW	HAVBA 220V-Three phase 1.5kw	HAVBA2T0015G	8.827.500
		2.2KW	HAVBA 220V-Three phase 2.2kw	HAVBA2T0022G	9.240.000
		3KW	HAVBA 220V-Three phase 3kw	HAVBA2T0030G	
	3Phase - 380V	0.75KW	HAVBA 380V-Three phase 0.75kw	HAVBA4T0007G	5.948.800
		1.5KW	HAVBA 380V-Three phase 1.5kw	HAVBA4T0015G	
		2.2KW	HAVBA 380V-Three phase 2.2kw	HAVBA4T0022G	
		3KW	HAVBA 380V-Three phase 3kw	HAVBA4T0030G	8.134.500
4KW		HAVBA 380V-Three phase 4kw	HAVBA4T0040G		
5.5KW		HAVBA 380V-Three phase 5.5kw	HAVBA4T0055G	8.610.800	

# Inverter



## HAVXS Expert Standard Inverter

Type	Input	Power Range	Drive Type	Range	Drive Type	Description	Model	Price
Expert Standard	1Phase - 220V	0.75KW	Heavy Duty	-	-	HAVXS 220V-Single Phase 0.75kw Heavy Duty	HAVXS2S0007G	10.549.000
		1.5KW		-	-	HAVXS 220V-Single Phase 1.5kw Heavy Duty	HAVXS2S0015G	11.671.000
		2.2KW		-	-	HAVXS 220V-Single Phase 2.2kw Heavy Duty	HAVXS2S0022G	11.869.000
	3Phase - 220V	0.75KW		-	-	HAVXS 220V-Three Phase 0.75kw Heavy Duty	HAVXS2T0007G	10.590.800
		1.5KW		-	-	HAVXS 220V-Three Phase 1.5kw Heavy Duty	HAVXS2T0015G	11.775.500
		2.2KW		-	-	HAVXS 220V-Three Phase 2.2kw Heavy Duty	HAVXS2T0022G	11.775.500
		3.7KW		-	-	HAVXS 220V-Three Phase 3.7kw Heavy Duty	HAVXS2T0040G	15.103.000
		5.5KW		-	-	HAVXS 220V-Three Phase 5.5kw Heavy Duty	HAVXS2T0055G	16.560.500
		7.5KW		-	-	HAVXS 220V-Three Phase 7.5kw Heavy Duty	HAVXS2T0075G	19.393.000
		11KW		-	-	HAVXS 220V-Three Phase 11kw Heavy Duty	HAVXS2T0110G	26.595.800
		15KW		-	-	HAVXS 220V-Three Phase 15kw Heavy Duty	HAVXS2T0150G	29.065.300
		18.5KW		-	-	HAVXS 220V-Three Phase 18.5kw Heavy Duty	HAVXS2T0185G	41.797.800
		22KW		-	-	HAVXS 220V-Three Phase 22kw Heavy Duty	HAVXS2T0220G	42.925.300
		30KW		-	-	HAVXS 220V-Three Phase 30kw Heavy Duty	HAVXS2T0300G	58.509.000
		37KW		-	-	HAVXS 220V-Three Phase 37kw Heavy Duty	HAVXS2T0370G	64.735.000
		45KW		-	-	HAVXS 220V-Three Phase 45kw Heavy Duty	HAVXS2T0450G	74.123.500
		55KW		-	-	HAVXS 220V-Three Phase 55kw Heavy Duty	HAVXS2T0550G	99.924.000
		75KW		-	-	HAVXS 220V-Three Phase 75kw Heavy Duty	HAVXS2T0750G	133.378.300
		90KW		-	-	HAVXS 220V-Three Phase 90kw Heavy Duty	HAVXS2T0900G	176.236.500
		110KW		-	-	HAVXS 220V-Three Phase 110kw Heavy Duty	HAVXS2T1100G	238.967.300
	132KW	-		-	HAVXS 220V-Three Phase 132kw Heavy Duty	HAVXS2T1320G	241.565.500	
	160KW	-		-	HAVXS 220V-Three Phase 160kw Heavy Duty	HAVXS2T1600G	328.806.500	
	3Phase - 380V	0.75KW		-	-	HAVXS 380V-Three Phase 0.75kw Heavy Duty	HAVXS4T0007G	10.582.000
		1.5KW		-	-	HAVXS 380V-Three Phase 1.5kw Heavy Duty	HAVXS4T0015G	10.681.000
2.2KW		-	-	HAVXS 380V-Three Phase 2.2kw Heavy Duty	HAVXS4T0022G	10.846.000		
850KW		-	-	HAVXS 380V-Three Phase 850kw Normal type	HAVXS4T8500G	1.586.379.300		

# Inverter



Type	Input	Power Range	Drive Type	Range	Drive Type	Description	Model	Price
Expert Standard	3Phase - 380V	3.7KW	Heavy Duty	5.5KW	Normal Type	HAVXS 380V-Three Phase 3.7kw/5.5kw Normal type	HAVXS4T0040G0055P	12.188.000
		5.5KW		7.5KW		HAVXS 380V-Three Phase 5.5kw/7.5kw Normal type	HAVXS4T0055G0075P	15.766.300
		7.5KW		11KW		HAVXS 380V-Three Phase 7.5kw/11kw Normal type	HAVXS4T0075G0110P	17.009.300
		11KW		15KW		HAVXS 380V-Three Phase 11kw/15kw Normal type	HAVXS4T0110G0150P	20.468.800
		15KW		18.5KW		HAVXS 380V-Three Phase 15kw/18.5kw Normal type	HAVXS4T0150G0185P	21.579.800
		18.5KW		22KW		HAVXS 380V-Three Phase 18.5kw/22kw Normal type	HAVXS4T0185G0220P	27.522.000
		22KW		30KW		HAVXS 380V-Three Phase 22kw/30kw Normal type	HAVXS4T0220G0300P	30.140.000
		30KW		37KW		HAVXS 380V-Three Phase 30kw/37kw Normal type	HAVXS4T0300G0370P	41.981.500
		37KW		45KW		HAVXS 380V-Three Phase 37kw/45kw Normal type	HAVXS4T0370G0450P	43.189.300
		45KW		55KW		HAVXS 380V-Three Phase 45kw/55kw Normal type	HAVXS4T0450G0550P	58.160.300
		55KW		75KW		HAVXS 380V-Three Phase 55kw/75kw Normal type	HAVXS4T0550G0750P	63.940.800
		75KW		90KW		HAVXS 380V-Three Phase 75kw/90kw Normal type	HAVXS4T0750G0900P	72.649.500
		90KW		110KW		HAVXS 380V-Three Phase 90kw/110kw Normal type	HAVXS4T0900G1100P	98.948.300
		110KW		132KW		HAVXS 380V-Three Phase 110kw/132kw Normal type	HAVXS4T1100G1320P	103.801.500
		132KW		160KW		HAVXS 380V-Three Phase 132kw/160kw Normal type	HAVXS4T1320G1600P	127.614.300
		160KW		185KW		HAVXS 380V-Three Phase 160kw/185kw Normal type	HAVXS4T1600G1850P	172.362.300
		185KW		200KW		HAVXS 380V-Three Phase 185kw/200kw Normal type	HAVXS4T1850G2000P	183.323.800
		200KW		220KW		HAVXS 380V-Three Phase 200kw/220kw Normal type	HAVXS4T2000G2200P	235.738.800
		220KW		250KW		HAVXS 380V-Three Phase 220kw/250kw Normal type	HAVXS4T2200G2500P	240.952.800
		250KW		280KW		HAVXS 380V-Three Phase 250kw/280kw Normal type	HAVXS4T2500G2800P	303.751.800
		280KW		315KW		HAVXS 380V-Three Phase 280kw/315kw Normal type	HAVXS4T2800G3150P	326.106.000
		315KW		355KW		HAVXS 380V-Three Phase 315kw/355kw Normal type	HAVXS4T3150G3550P	366.300.000
		355KW		400KW		HAVXS 380V-Three Phase 355kw/400kw Normal type	HAVXS4T3550G4000P	433.914.800
		400KW		450KW		HAVXS 380V-Three Phase 400kw/450kw Normal type	HAVXS4T4000G4500P	459.055.300
		450KW		500KW		HAVXS 380V-Three Phase 450kw/500kw Normal type	HAVXS4T4500G5000P	566.052.300
		500KW		560KW		HAVXS 380V-Three Phase 500kw/560kw Normal type	HAVXS4T5000G5600P	799.433.800
560KW	630KW	HAVXS 380V-Three Phase 560kw/630kw Normal type	HAVXS4T5600G6300P	942.356.800				
630KW	710KW	HAVXS 380V-Three Phase 630kw/710kw Normal type	HAVXS4T6300G7100P	958.290.300				
710KW	850KW	HAVXS 380V-Three Phase 710kw/850kw Normal type	HAVXS4T7100G8500P	1.562.247.500				

# Inverter











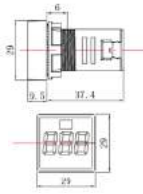

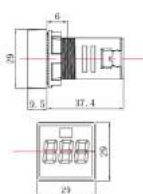
## HAVSP Smart Pump Inverter

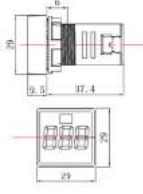
Type	Input	Power Range	Drive Type	Description	Model	Price		
Smart Pump	3Phase - 220V	2.2KW	Normal-duty	HAVSP 220V-Three Phase 2.2kw Normal-duty	HAVSP2T0022P	13.522.300		
		3.0KW		HAVSP 220V-Three Phase 3.0kw Normal-duty	HAVSP2T0030P	14.157.000		
		4.0KW		HAVSP 220V-Three Phase 4.0kw Normal-duty	HAVSP2T0040P			
		5.5KW		HAVSP 220V-Three Phase 5.5kw Normal-duty	HAVSP2T0055P	16.780.500		
		7.5KW		HAVSP 220V-Three Phase 7.5kw Normal-duty	HAVSP2T0075P	18.400.800		
		11KW		HAVSP 220V-Three Phase 11kw Normal-duty	HAVSP2T0110P	21.981.300		
		15KW		HAVSP 220V-Three Phase 15kw Normal-duty	HAVSP2T0150P	23.262.800		
		18.5KW		HAVSP 220V-Three Phase 18.5kw Normal-duty	HAVSP2T0185P	30.503.000		
		22KW		HAVSP 220V-Three Phase 22kw Normal-duty	HAVSP2T0220P	35.857.800		
		30KW		HAVSP 220V-Three Phase 30kw Normal-duty	HAVSP2T0300P	42.790.000		
		37KW		HAVSP 220V-Three Phase 37kw Normal-duty	HAVSP2T0370P	47.930.300		
		45KW		HAVSP 220V-Three Phase 45kw Normal-duty	HAVSP2T0450P	61.009.300		
		3Phase - 380V		2.2KW	Normal-duty	HAVSP 380V-Three Phase 2.2kw Normal-duty	HAVSP4T0022P	13.260.500
				3.0KW		HAVSP 380V-Three Phase 3.0kw Normal-duty	HAVSP4T0030P	13.522.300
	4.0KW		HAVSP 380V-Three Phase 4.0kw Normal-duty	HAVSP4T0040P				
	5.5KW		HAVSP 380V-Three Phase 5.5kw Normal-duty	HAVSP4T0055P		13.816.000		
	7.5KW		HAVSP 380V-Three Phase 7.5kw Normal-duty	HAVSP4T0075P		11.608.740		
	11KW		HAVSP 380V-Three Phase 11kw Normal-duty	HAVSP4T0110P		14.095.620		
	15KW		HAVSP 380V-Three Phase 15kw Normal-duty	HAVSP4T0150P		16.192.704		
	18.5KW		HAVSP 380V-Three Phase 18.5kw Normal-duty	HAVSP4T0185P		20.222.796		
	22KW		HAVSP 380V-Three Phase 22kw Normal-duty	HAVSP4T0220P		22.564.916		
	30KW		HAVSP 380V-Three Phase 30kw Normal-duty	HAVSP4T0300P		30.038.800		
	37KW		HAVSP 380V-Three Phase 37kw Normal-duty	HAVSP4T0370P		35.857.800		
	45KW		HAVSP 380V-Three Phase 45kw Normal-duty	HAVSP4T0450P		42.790.000		
	55KW		HAVSP 380V-Three Phase 55kw Normal-duty	HAVSP4T0550P		47.930.300		
	75KW		HAVSP 380V-Three Phase 75kw Normal-duty	HAVSP4T0750P		60.186.500		
	90KW	HAVSP 380V-Three Phase 90kw Normal-duty	HAVSP4T0900P	74.233.500				
	110KW	HAVSP 380V-Three Phase 110kw Normal-duty	HAVSP4T1100P	109.070.500				
132KW	HAVSP 380V-Three Phase 132kw Normal-duty	HAVSP4T1320P	122.202.300					
160KW	HAVSP 380V-Three Phase 160kw Normal-duty	HAVSP4T1600P	150.568.000					

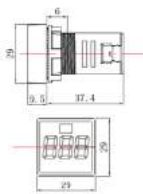

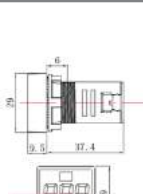
# Indicator Light & Push Button

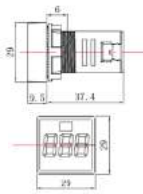
## HLD12 Indicator Light

Picture	Structure Drawing	Type	Voltage/Current /Frequency /Temperature	Color	Description	Model	Price
		Indicator Voltmeter	AC 50 ~ 500V	Green	Square, voltmeter, green,AC:50V-500V	HLD1222VSG	85.800
				Red	Square, voltmeter, red,AC:50V-500V	HLD1222VSR	
				Yellow	Square, voltmeter, yellow,AC:50V-500V	HLD1222VSY	
				Blue	Square, voltmeter, blue,AC:50V-500V	HLD1222VSB	
				White	Square, voltmeter, white,AC:50V-500V	HLD1222VSW	
		Indicator Ammeter	0 ~ 100A Max AC 380V	Green	Square, ammeter, green,0-100A	HLD1222ASG	167.200
				Red	Square, ammeter, red,0-100A	HLD1222ASR	
				Yellow	Square, ammeter, yellow,0-100A	HLD1222ASY	
				Blue	Square, ammeter, blue,0-100A	HLD1222ASB	
				White	Square, ammeter, white,0-100A	HLD1222ASW	
		Indicator Frequency meter	0 ~ 99Hz	Green	Square, Hertz meter, green,0-99HZ	HLD1222HZSG	73.700
				Red	Square, Hertz meter, red,0-99HZ	HLD1222HZSR	
				Yellow	Square, Hertz meter, yellow,0-99HZ	HLD1222HZSY	
				Blue	Square, Hertz meter, blue,0-99HZ	HLD1222HZSB	
				White	Square, Hertz meter, white,0-99HZ	HLD1222HZSW	
		Indicator Thermometer	0°C ~+199°C	Green	Square,thermometer, Green,0-199°	HLD1222TSG	181.500
				Red	Square,thermometer, red,0-199°	HLD1222TSR	
				Yellow	Square,thermometer, yellow,0-199°	HLD1222TSY	
				Blue	Square,thermometer, blue,0-199°	HLD1222TSB	
				White	Square,thermometer, white,0-199°	HLD1222TSW	
		Indicator Voltmeter& Ammeter	AC50-500V 0-100A	Green	Square, ammeter and voltmeter, green, AC:50V-500V,0-100A	HLD1222VASG	189.200
				Red	Square, ammeter and voltmeter, red, AC:50V-500V,0-100A	HLD1222VASR	
				Yellow	Square, ammeter and voltmeter, yellow, AC:50V-500V,0-100A	HLD1222VASY	
				Blue	Square, ammeter and voltmeter, blue, AC:50V-500V,0-100A	HLD1222VASB	
				White	Square, ammeter and voltmeter, white, AC:50V-500V,0-100A	HLD1222VASW	
		Indicator Voltmeter& Ammeter Frequency meter	AC50-500V 0-100A 0-99Hz	Green	Square, ammeter and voltmeter, Hertz meter, green,AC:50-500V; 0-100A,0-90HZ	HLD1222VAZSG	267.300
				Red	Square, ammeter and voltmeter, Hertz meter,red, AC:50-500V;0-100A,0-90HZ	HLD1222VAZSR	
				Yellow	Square, ammeter and voltmeter, Hertz meter, yellow,AC:50-500V; 0-100A,0-90HZ	HLD1222VAZSY	
				Blue	Square, ammeter and voltmeter, Hertz meter,blue, AC:50-500V;0-100A,0-90HZ	HLD1222VAZSB	
				White	Square, ammeter and voltmeter, Hertz meter, white, AC:50-500V; 0-100A,0-90HZ	HLD1222VAZSW	



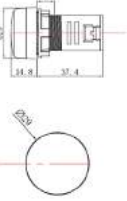







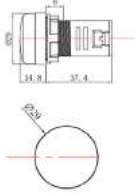

# Indicator Light & Push Button

## HLD12 Indicator Light

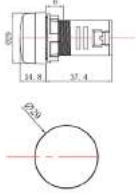
Picture	Structure Drawing	Type	Voltage/Current /Frequency /Temperature	Color	Description	Model	Price
		Indicator Voltmeter	AC50~500V	Green	Round,voltmeter, green,AC:50-500V	HLD1222VMG	82.500
				Red	Round,voltmeter, red,AC:50-500V	HLD1222VMR	
				Yellow	Round,voltmeter, yellow,AC:50-500V	HLD1222VMY	
				Blue	Round,voltmeter, blue,AC:50-500V	HLD1222VMB	
				White	Round,voltmeter, white,AC:50-500V	HLD1222VMW	
		Indicator Ammeter	0~100A Max AC380V	Green	Round,ammeter, green, 0-100A	HLD1222AMG	167.200
				Red	Round,ammeter, red, 0-100A	HLD1222AMR	
				Yellow	Round,ammeter, yellow, 0-100A	HLD1222AMY	
				Blue	Round,ammeter, blue, 0-100A	HLD1222AMB	
				White	Round,ammeter, white, 0-100A	HLD1222AMW	
		Indicator Frequency meter	0-99Hz	Green	Round,Hertz meter, green,0-90HZ	HLD1222HZMG	82.500
				Red	Round,Hertz meter, red,0-90HZ	HLD1222HZMR	
				Yellow	Round,Hertz meter, yellow,0-90HZ	HLD1222HZMY	
				Blue	Round,Hertz meter, blue,0-90HZ	HLD1222HZMB	
				White	Round,Hertz meter, white,0-90HZ	HLD1222HZMW	
		Indicator Thermometer	0°C ~199°C	Green	Round,thermometer, green,0-199°	HLD1222TMG	169.400
				Red	Round,thermometer, red,0-199°	HLD1222TMR	
				Yellow	Round,thermometer, yellow,0-199°	HLD1222TMY	
				Blue	Round,thermometer, blue,0-199°	HLD1222TMB	
				White	Round,thermometer, white,0-199°	HLD1222TMW	
		Indicator Voltmeter & Ammeter	AC50-500V 0-100A	Green	Round, ammeter and voltmeter, green, AC:50-500V;0-100A,	HLD1222VAMG	201.300
				Red	Round, ammeter and voltmeter, red, AC:50-500V;0-100A,	HLD1222VAMR	
				Yellow	Round, ammeter and voltmeter, yellow, AC:50-500V;0-100A,	HLD1222VAMY	
				Blue	Round, ammeter and voltmeter, blue, AC:50-500V;0-100A,	HLD1222VAMB	
				White	Round, ammeter and voltmeter, white, AC:50-500V;0-100A,	HLD1222VAMW	

# Indicator Light & Push Button

## HLD12 Indicator Light

Picture	Structure Drawing	Type	Voltage/Current /Frequency /Temperature	Color	Description	Model	Price
		Indicator	AC/DC 24V	 Green	Pilot light 22mm AC/DC 24V Green	HLD1222PDG	26.400
				 Red	Pilot light 22mm AC/DC 24V Red	HLD1222PDR	
				 Yellow	Pilot light 22mm AC/DC 24V Yellow	HLD1222PDY	
				 Blue	Pilot light 22mm AC/DC 24V Blue	HLD1222PDB	
				 White	Pilot light 22mm AC/DC 24V White	HLD1222PDW	
		Indicator	AC 240V	 Green	Pilot light 22mm AC 240V Green	HLD1222PAG	
				 Red	Pilot light 22mm AC 240V Red	HLD1222PAR	
				 Yellow	Pilot light 22mm AC 240V Yellow	HLD1222PAY	
				 Blue	Pilot light 22mm AC 240V Blue	HLD1222PAB	
				 White	Pilot light 22mm AC 240V White	HLD1222PAW	

## HLD12 Potentiometer

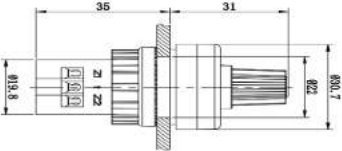
Picture	Structure Drawing	Description	Model	Price
		potentiometer,22mm ,1K $\Omega$	HLD1222KBR1	178.200
		potentiometer,22mm ,2K $\Omega$	HLD1222KBR2	
		potentiometer,22mm ,5K $\Omega$	HLD1222KBR5	
		potentiometer,22mm ,10K $\Omega$	HLD1222KBR10	
		potentiometer,22mm ,20K $\Omega$	HLD1222KBR20	189.200
		potentiometer,22mm ,50K $\Omega$	HLD1222KBR50	
		potentiometer,22mm ,100K $\Omega$	HLD1222KBR100	
		potentiometer,22mm ,200K $\Omega$	HLD1222KBR200	



# Indicator Light & Push Button











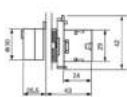









## HLAY2 Push Button

Picture	Structure Drawing	Type	Contact Type		Color	Description	Model	Price
			NO	NC				
		Flat Push Button Switch	1	-	White	Push button, Plastic, flush,White, 1NO, UI:415V	HLAY2EA11	30.800
			1	1	White	Push button, Plastic, flush,White, 1NO&1NC, UI:415V	HLAY2EA15	45.100
			1	-	Black	Push button, Plastic, flush, Black, 1NO, UI:415V	HLAY2EA21	30.800
			1	1	Black	Push button, Plastic, flush,Black, 1NO&1NC, UI:415V	HLAY2EA25	45.100
			1	-	Green	Push button, Plastic ,flush, Green, 1NO, UI:415V	HLAY2EA31	30.800
			1	1	Green	Push button, Plastic ,flush, Green, 1NO&1NC, UI:415V	HLAY2EA35	45.100
			-	1	Red	Push button, Plastic ,flush, Red, 1NC, UI:415V	HLAY2EA42	30.800
			1	1	Red	Push button, Plastic ,flush, Red, 1NO&1NC, UI:415V	HLAY2EA45	45.100
			1	-	Yellow	Push button, Plastic ,flush, Yellow, 1NO, UI:415V	HLAY2EA51	30.800
			1	1	Yellow	Push button, Plastic ,flush, Yellow, 1NO&1NC, UI:415V	HLAY2EA55	45.100
			1	-	Blue	Push button, Plastic ,flush, Blue, 1NO, UI:415V	HLAY2EA61	30.800
			1	1	Blue	Push button, Plastic ,flush, Blue, 1NO&1NC, UI:415V	HLAY2EA65	45.100
		Mark Push Button	1	-	Green	Push button, Plastic,22mm,marked White I,flush,Green,1NO,UI:415V	HLAY2EA3311	45.100
			1	-	Black	Push button, Plastic,22mm ,marked Black ARROW,flush,White,1NO,UI:415V	HLAY2EA3341	
			1	-	Black	Push button, Plastic ,22mm,marked White arrow,flush, black,1NO,UI:415V	HLAY2EA3351	
			1	-	Green	Push button, Plastic ,22mm,marked White II,flush,Green,1NO,UI:415V	HLAY2EA3361	
			-	1	Red	Push button, Plastic,22mm ,marked White O,flush,Red,1NC,UI:415V	HLAY2EA4322	
			-	1	Red	Push button, Plastic,22mm ,marked White stop,flush,Red,1NC,UI:415V	HLAY2EA4342	
			1	-	Green	Push button, Plastic,22mm,marked White Start,flush,Green,1NO,UI:415V	HLAY2EA4331	
		Mushroom Head Push Button	1	-	Black	Mushroom head pushbuttons, Plastic, φ40,Black,1NO,UI:415V	HLAY2EC21	52.800
			1	-	Green	Mushroom head pushbuttons, Plastic ,φ40,Green,1NO,UI:415V	HLAY2EC31	
			-	1	Red	Mushroom head pushbuttons, Plastic ,φ40,Red,1NC,UI:415V	HLAY2EC42	
			1	-	Black	Mushroom head pushbuttons, Plastic ,φ60,Black,1NO,UI:415V	HLAY2ER21	59.400
			1	-	Green	Mushroom head pushbuttons, Plastic ,φ60,Green,1NO,UI:415V	HLAY2ER31	
			-	1	Red	Mushroom head pushbuttons, Plastic ,φ60,Red,1NC,UI:415V	HLAY2ER42	
		Emergency stop button	-	1	Red	Emergency stop button, Turn to release,φ30,Red,1NC,UI:415V	HLAY2ES442	59.400
			-	1	Red	Emergency stop button, Turn to release,φ40,Red,1NC,UI:415V	HLAY2ES542	
			-	1	Red	Emergency stop button, Turn to release,φ60,Red,1NC,UI:415V	HLAY2ES642	67.100
			-	1	Red	Emergency stop button, key reset,φ40,Red,1NC,UI:415V	HLAY2ES142	139.700



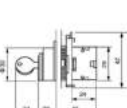





# Indicator Light & Push Button

## HLAY2 Push Button

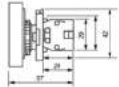
Picture	Structure Drawing	Type	Contact Type		Color	Description	Model	Price
			NO	NC				
		2-Position Maintain	1	-		Selector switches , Plastic 2-position,standard handle,stay put,Black,1NO,Ul:415V	HLAY2ED21	45.100
			1	1		Selector switches , Plastic 2-position,standard handle, stay put,Black,1NO+1NC,Ul:415V	HLAY2ED25	57.200
		2-Position Spring	1	-		Selector switches , Plastic 2-position,standard handle,Spring return ,Black,1NO,Ul:415V	HLAY2ED41	45.100
			1	1		Selector switches , Plastic 2-position,standard handle,Spring return ,Black,1NO&1NC,Ul:415V	HLAY2ED45	57.200
		3-Position Maintain	2	-		Selector switches , Plastic 3-position,standard handle,stay put,Black,2NO,Ul:415V	HLAY2ED33	
		3-Position Spring	2	-		Selector switches , Plastic 3-position,standard handle,Spring return to center,Black,2NO,Ul:415V	HLAY2ED53	59.400
			2	-		Selector switches , Plastic 3-position, standard handle,left spring return ,right stay put ,Black,Black,2NO,Ul:415V	HLAY2ED73	81.400
			2	-		Selector switches , Plastic 3-position, standard handle,Right spring return ,left stay put ,Black,2NO,Ul:415V	HLAY2ED83	
				2-Position Maintain	1	-		Selector switches with long handle, plastic, 2-position,Stayput,Black, 1NO,Ul:415V
1	1				Selector switches with long handle, plastic , 2-position,Stay put,Black, 1NO&1NC,Ul:415V	HLAY2EJ25		57.200
2-Position Spring	1			-		Selector switches , Plastic 2-position, long handle,Spring return,Black, 1NO,Ul:415V	HLAY2EJ41	45.100
	1			1		Selector switches , Plastic 2-position, long handle,Spring return ,Black,1NO&1NC,Ul:415V	HLAY2EJ45	57.200
3-Position Maintain	2			-		Selector switches with long handle, plastic,3-position,Stay put,Black,2NO,Ul:415V	HLAY2EJ33	
3-Position Spring	2			-		Selector switches , Plastic 3-position,long handle,Spring return to center,Black,2NO,Ul:415V	HLAY2EJ53	59.400
	2			-		Selector switches , Plastic 3-position, long handle,right stay, left spring return,Black,2NO,Ul:415V	HLAY2EJ73	81.400
	2			-		Selector switches , Plastic 3-position,long handle,left stay, right srping return,Black,2NO,Ul:415V	HLAY2EJ83	
				2-Position Switch with Key	1	-		Key switches , Plastic 2-position,key withdrawal from 1 position,1NO,Ul:415V
		1	1		Key switches , Plastic 2-position, key withdrawal from 1 position, 1NO&1NC,Ul:415V	HLAY2EG25		116.600
		1	-		Key switches , Plastic 2-position,stay put,key withdrawal from 2 position,1NO,Ul:415V	HLAY2EG41		106.700
		1	1		Key switches , Plastic 2-position,stay put ,key withdrawal from 2 position,1NO&1NC,Ul:415V	HLAY2EG45		118.800
		1	-		Key switches , Plastic 2-position,Spring return,key withdrawal from 1 position,1NO,Ul:415V	HLAY2EG61		106.700
		1	1		Key switches , Plastic 2-position,Spring return,key withdrawal from 1 position,1NO&1NC,Ul:415V	HLAY2EG65		118.800
		3-Position Switch with Key	2	-		Key switches , Plastic 3-position,stay put,key withdrawal from 1 position,2NO,Ul:415V	HLAY2EG33	116.600
			2	-		Key switches , Plastic 3-position,Spring return to center,key withdrawal from 1 position,2NO,Ul:415V	HLAY2EG53	118.800
			2	-		Key switches , Plastic 3-position,3 sides stay put,key withdrawal from 3 position, 2NO,Ul:415V	HLAY2EG03	

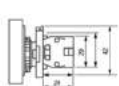
# Indicator Light & Push Button

## HLAY2 Push Button

Picture	Structure Drawing	Type	Contact Type		Color	Description	Model	Price
			NO	NC				
		Double head push button with light	1	1		Double-headed , Plastic , 2 flush green&red +1 pilot light,1NO+1NC,240V	HLAY2EW8365M	124.300
			1	1		Double-headed , Plastic , 2 flush green&red +1 pilot light,1NO+1NC,24V	HLAY2EW8365B	
		Double head push button with light	1	1		Double-headed , Plastic , 1 flush green +1 projectin Red +1 pilot light,1NO+1NC,240V	HLAY2EW8465M	
			1	1		Double-headed , Plastic , 1 flush green +1 projectin Red +1 pilot light block,1NO+1NC,24V	HLAY2EW8465B	
		Double head push button	1	1		Double-headed pushbutton,, Plastic , 2 flush green&red push-es,1NO+1NC,UI:415V	HLAY2EL8325	78.100
		Double head push button	1	1		Double-headed pushbutton, Plastic , (1 flush green +1 projecting Red),1NO+1NC,UI:415V	HLAY2EL8425	
		Waterproof Double head push button	1	1		Double-headed pushbutton,water proof, Plastic , flush green&red push-es,1NO+1NC,UI:415V	HLAY2EL9325	88.000
		Waterproof Double head push button	1	1		Double-headed pushbutton,water proof, Plastic , (1 flush green +1 projecting Red),1NO+1NC,UI:415V	HLAY2EL9425	
		Illuminated push button	1	-	 White 24V	illuminated push button, plastic , 22mm ,white,NO,24V	HLAY2EW3161B	78.100
			1	-	 Green 24V	illuminated push button, plastic , 22mm ,Green,NO,24V	HLAY2EW3361B	
			1	-	 Yellow 24V	illuminated push button, plastic , 22mm ,yellow,NO,24V	HLAY2EW3561B	
			1	-	 Blue 24V	illuminated push button, plastic , 22mm ,blue,NO,24V	HLAY2EW3661B	
			-	1	 Red 24V	illuminated push button, plastic , 22mm ,red,NC,24V	HLAY2EW3462B	
		Illuminated push button	1	-	 White 240V	illuminated push button, plastic , 22mm ,white,NO,240V	HLAY2EW3171M	86.900
			1	-	 Green 240V	illuminated push button, plastic , 22mm ,Green,NO,240V	HLAY2EW3371M	
			1	-	 Yellow 240V	illuminated push button, plastic , 22mm ,yellow,NO,240V	HLAY2EW3571M	
			1	-	 Blue 240V	illuminated push button, plastic, 22mm ,blue,NO,240V	HLAY2EW3671M	
			-	1	 Red 240V	illuminated push button, plastic , 22mm ,Red,NC,240V	HLAY2EW3472M	
		Contact Block	1	-	-	Contact assemblies,1NO,UI:415V	HLAY2BE101	13.200
			-	1	-	Contact assemblies,1NC,UI:415V	HLAY2BE102	

# Globally Present. Committed to Quality.

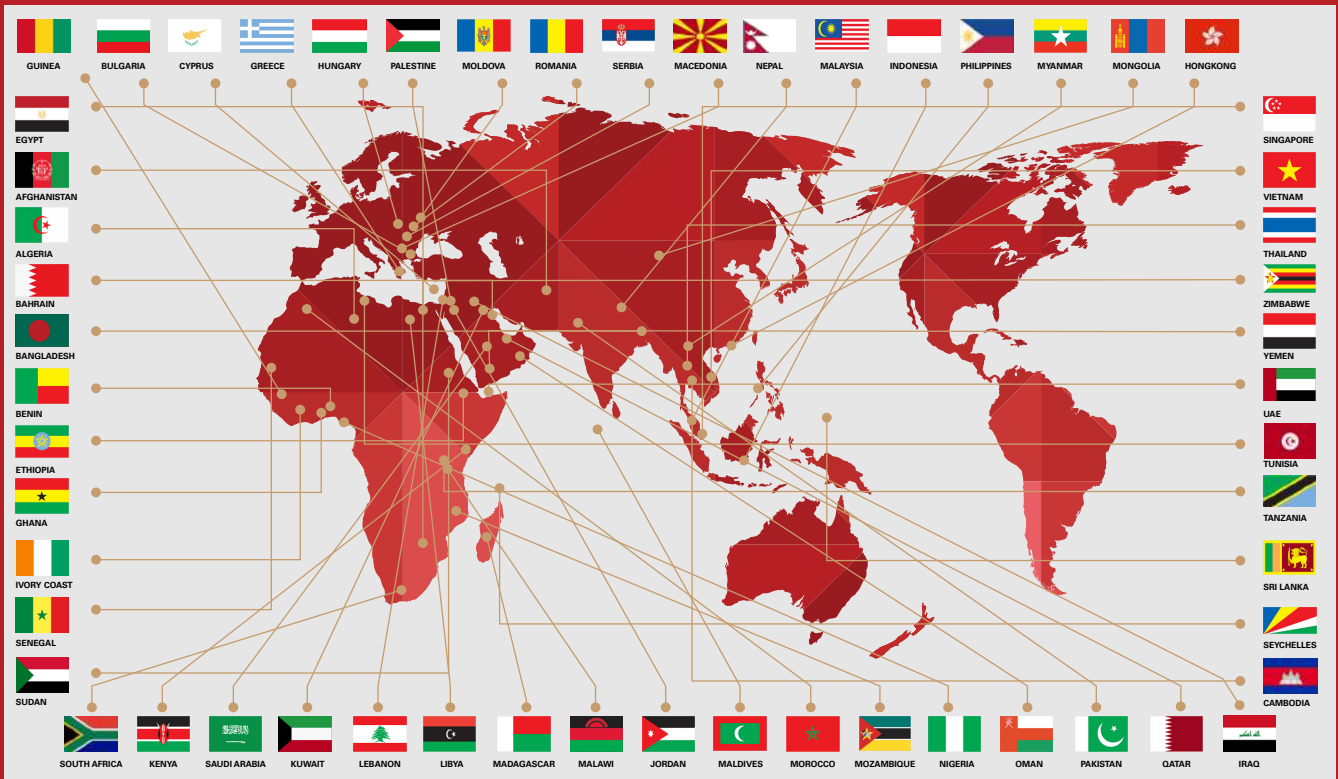

Scan to connect with Himel





## CONTACT US



Get in touch with HimelTeam at <https://www.himel.com/contact-us>



Find Promax, The Local Himel Distributor at <https://www.facebook.com/promaxelectric>



Visit Himel Website at <https://www.himel.com>



Reach Himel Global Team at [support@himel.com](mailto:support@himel.com)

Reach Promax Team at [promax.himel@gmail.com](mailto:promax.himel@gmail.com)  
[\(028\) 3762 0468 69](tel:(028)3762046869)



Contact Global Himel Marketing & Communication Team at [sm.himel.communications@himel.com](mailto:sm.himel.communications@himel.com)